

# Proficiency testing Food Microbiology

January 2023

Jonas Ilbäck

---

This report is available at: <https://www.livsmedelsverket.se/en/PT-micro>

© Swedish Food Agency, 2023.

*Author*

Jonas Ilbäck

*Recommended citation*

Ilbäck, J. 2023. Proficiency testing Food Microbiology – January 2023, Swedish Food Agency, Uppsala, Sweden.

*Edition*

Version 1 (2023-04-13)

*Editor in chief*

Maria Sitell, head of the Department of Biology, Swedish Food Agency

*Responsible for the scheme*

Jonas Ilbäck, microbiologist, Department of Biology, Swedish Food Agency

PT Food January 2023 is registered as no. 2022/04367 at the Swedish Food Agency



# Contents

Abbreviations .....	4
Analyses in this PT round .....	7
Method.....	8
Results .....	11
Aerobic microorganisms, 30 °C .....	12
Enterobacteriaceae .....	15
Thermotolerant <i>Campylobacter</i> .....	17
<i>Listeria monocytogenes</i> .....	19
<i>Salmonella</i> .....	22
<i>Escherichia coli</i> O157 .....	24
Pathogenic <i>Vibrio</i> spp.....	26
<i>Yersinia enterocolitica</i> .....	28
Outcome of the results of individual participants - assessment.....	30
Test material and quality control .....	35
References.....	37

# Abbreviations

## Media

ALOA	Agar for <i>Listeria</i> according to Ottaviani & Agosti
APW 2%	Alcaline peptone water, 2 % NaCl
BA	Blood agar
BcsA	<i>Bacillus cereus</i> selective agar
BEA	Bile esculin agar
BGA	Brilliant green agar
BGLB	Brilliant green lactose bile broth
BP	Baird-Parker agar
BPW	Buffered peptone water
BS	Bromthymol blue saccharose agar
CBC	Oxoid Brilliance™ <i>Bacillus cereus</i> agar
CIN	Cefsulodin irgasan novobiocin agar
Compact Dry EC	Compact Dry™ <i>E. coli</i> and coliforms
Compact Dry ETB	Compact Dry™ Enterobacteriaceae
Compact Dry ETC	Compact Dry™ Enterococcus
Compact Dry TC	Compact Dry™ Total Count
COMPASS	COMPASS® Enterococcus agar
CT-SMAC	Cefixime tellurite sorbitol MacConkey agar
DG18	Dikloran glycerol agar
DRBC	Dikloran Rose-Bengal chloramphenicol agar
EC	<i>E. coli</i> broth
ENT	Slanetz & Bartley <i>Enterococcus</i> agar
HEA	Hektoen enteric agar
IA	Iron agar
ISA	Iron sulphite agar
ITC	Irgasan ticarcillin potassium chlorate broth
KEAA	Kanamycin esculin azide agar
LMBA	<i>Listeria monocytogenes</i> blood agar
LSB	Lauryl sulphate broth
LTLSB	Lactose tryptone lauryl sulphate broth
mCCDA	Modified charcoal cephaloperazone deoxycholate agar
mCP	Membrane <i>Clostridium perfringens</i> agar
MKTTn	Muller-Kauffmann tetrathionate/novobiocin broth
MPCA	Milk plate count agar
MRB	Modified Rappaport broth
MRS	de Man, Rogosa and Sharpe agar
MRS-aB	de Man, Rogosa and Sharpe agar with amphotericin
MRS-S	de Man, Rogosa and Sharpe agar with sorbic acid
MSRV	Modified semi-solid Rappaport-Vassiliadis enrichment media
mTSB	Modified tryptone soya broth

MYP	Mannitol egg yolk polymyxin agar
OCLA	Oxoid Brilliance™ Listeria agar
OGYE	Oxytetracyclin glucose yeast extract agar
OPSP	Oleandomycin, Polymixin, Sulphadiazine, Perfringens agar
PAB	Perfringens agar base
PDA	Potato dextrose agar
PALCAM	Polymyxin acriflavine lithium chloride ceftazidime aesculin mannitol agar
Petrifilm AC	3M™ Petrifilm™ Aerobic Count
Petrifilm CC	3M™ Petrifilm™ Coliform count
Petrifilm Disk	3M™ Petrifilm™ Staph Express Disk
Petrifilm EB	3M™ Petrifilm™ Enterobacteriaceae
Petrifilm EC/CC	3M™ Petrifilm™ <i>E. coli</i> /Coliform count
Petrifilm EL	3M™ Petrifilm™ Environmental Listeria
Petrifilm LAB	3M™ Petrifilm™ Lactic acid bacteria
Petrifilm RAC	3M™ Petrifilm™ Rapid Aerobic Count
Petrifilm REC	3M™ Petrifilm™ Rapid <i>E. coli</i> /Coliform count
Petrifilm SEC	3M™ Petrifilm™ Select <i>E. coli</i>
Petrifilm Staph	3M™ Petrifilm™ Staph Express
PEMBA	Polymyxin pyruvate egg yolk mannitol bromothymol blue agar
PSB	Peptone sorbitol bile salts broth
PCA	Plate count agar
RPFA	Baird-Parker agar with rabbit plasma fibrinogen
SFA	Sugar-free agar
RVS	Rappaport-Vassiliadis Soy peptone broth
Saubouraud	Saubouraud chloramphenicol agar
SC	Sulphite cycloserine agar
SFP	Shahidi-Ferguson Perfringens agar
SMAC	Sorbitol MacConkey agar
SP	Salt Polymyxin broth
SSDC	Salmonella/Shigella sodium deoxycholate calcium chloride agar
TBX	Tryptone bile X-glucuronide agar
TCBS	Thiosulphate citrate bile salts sucrose agar
TGE	Tryptone glucose extract agar
TEMPO AC	TEMPO® Aerobic count
TEMPO BC	TEMPO® <i>Bacillus cereus</i>
TEMPO CAM	TEMPO® Campylobacter
TEMPO CC	TEMPO® Coliform count
TEMPO EB	TEMPO® Enterobacteriaceae
TEMPO EC	TEMPO® <i>E. coli</i>
TEMPO RYM	TEMPO® Rapid Yeast/Mould
TEMPO STA	TEMPO® Coagulase-positive staphylococci
TEMPO YM	TEMPO® Yeast/Mould
TGE	Tryptone glucose extract agar
TS	Tryptose sulphite agar
TSA	Tryptic soya agar

TSC	Tryptose sulphite cycloserine agar
TSBY	Tryptone soya broth with yeast extract
XLD	Xylose lysine deoxycholate agar
VRB	Violet red bile agar
VRBG	Violet red bile glucose agar
YGC	Yeast extract glucose chloramphenicol agar

## Organisations

AFNOR	French National Standardization Association
AOAC	AOAC INTERNATIONAL
ATCC	American Type Culture Collection
CBS	Centraalbureau voor Schimmelcultures (Westerdijk Institute)
CCUG	Culture Collection University of Gothenburg
IDF	International Dairy Foundation
ISO	International Organization for Standardization
NMKL	Nordic-Baltic Committee on Food Analyses
NordVal	NordVal International - NMKL
SLV	Livsmedelsverket/Swedish Food Agency, Sweden
Fohm	Public Health Agency of Sweden

# Analyses in this PT round

## Quantitative analyses

Aerobic microorganisms, 30 °C

Enterobacteriaceae

Thermotolerant *Campylobacter*

*Listeria monocytogenes*

*Salmonella*

*Escherichia coli* O157

Pathogenic *Vibrio* spp.

*Yersinia enterocolitica*

# Method

## Reporting of results and method information

It is the responsibility of the individual participants to correctly report results according to the instructions. Incorrectly reported results, for example results reported for the wrong sample, cannot be correctly processed. Incorrectly reported results are as a general rule excluded but may – after manual assessment by the Swedish Food Agency in each individual case – still be included and processed.

It is also mandatory for the participants to report method information for all analyses. This method information is sometimes contradictory or difficult to interpret. For example when participants state a medium that is not included in the standard method they refer to, or when manual comments by the participant contradict the reported method information. In such cases, the reported method information provided by the participants is generally used in method comparisons “as it is”. Alternatively, method data that are difficult to interpret may be excluded or added to the group “Other”, together with results from methods and media that are only used by 1–2 participants.

## Standard deviation and assigned value

Evaluation of the participants’ results and statistical calculations are carried out on the  $\log_{10}$  transformed results. Results reported by participants as “> value” are not evaluated. Results reported as “< value” are treated as zero (negative result).

A robust statistical approach is used to determine the mean value and standard deviation. Algorithm A with iterated scale as described in ISO 13528:2022 [1] is used to determine the robust mean ( $m_{PT}$ ) and robust standard deviation ( $s_{PT}$ ) of the participants’ results. Results that are obviously erroneous are excluded prior to determining  $m_{PT}$  and  $s_{PT}$  (blunder removal). For evaluated parameters, the assigned value consists of  $m_{PT}$ . It is regarded as the true, normative value. For parameters that are not statistically evaluated, the median (Med) of the participants results is instead used as the assigned value. This is also normally the case for parameters with fewer than 20 reported results.

## Outliers

Outliers are results that deviate from the other results in a way that cannot be explained by normal variation. Results within  $m_{PT} \pm 3s_{PT}$  are considered acceptable, whereas results outside this interval are considered as outliers. When fewer than 20 participants have reported results, as well as in some individual cases, subjective adjustments are made to set acceptance limits based on prior knowledge of the samples contents.

## Results from different methods

*Non-robust* mean values ( $m$ ) and standard deviations ( $s$ ) and median values (Med) are calculated to assist in the evaluation of the results from different methods. These are shown in tables in the report, in connection with the respective analyses. In these instances,  $m$ ,  $s$  and Med are calculated from the



respective method groups' results, with outliers and false results excluded. Normally, for method groups with fewer than 5 results, only the number of false results and outliers are provided.

## Measurement uncertainty for the assigned values

The standard uncertainty ( $u_{PT}$ ) of the assigned value ( $m_{PT}$ ) is estimated from the standard deviation ( $s_{PT}$ ) and the number of evaluated results ( $n$ ):

$$u_{PT} = 1,25 \times \frac{s_{PT}}{\sqrt{n}}$$

The measurement uncertainty is considered negligible compared to the standard deviation (which is used for evaluating the participants' results) when:

$$u_{PT} < 0,3s_{PT}$$

## Z-scores

To allow comparison of the results from different analyses and samples, results are transformed into standard values (z-scores). Z-scores are calculated as:

$$z = \frac{x_{lab} - m_{PT}}{s_{PT}}$$

where  $x_{lab}$  is the result of the individual participant.

Z-scores for individual analyses are shown in Annex 2 and can be used as a tool by participants when following up on the results. For quantitative analyses, a z-score is either positive or negative, depending on whether the participants result is higher or lower than  $m_{PT}$ .

In evaluations of the analytical results, the following guidelines can be used:

- $|z| \leq 2$  indicates that the result is acceptable
- $2 < |z| < 3$  indicates a warning that the result may be deviating, and might motivate an action in the follow-up process
- $|z| \geq 3$  indicates that the result is regarded as deviating and should lead to an action in the follow-up process

## Table legends

- N number of participants that reported results for the analysis
- n number of participants with satisfactory result (false results and outliers excluded)
- $m_{PT}$  assigned value, robust mean value in  $\log_{10}$  cfu ml<sup>-1</sup>
- $s_{PT}$  robust standard deviation
- $u_{PT}$  standard uncertainty of the assigned value
- F number of false positive or false negative results
- < number of low outliers
- > number of high outliers
-  results deviating more than 1  $s_{PT}$  from m, or unusually many deviating results.

## Figure legends

- results within the interval of acceptance
- outlier
- false negative result
- \* value outside the x-axis scale

# Results

## General outcome

Samples were sent to 137 participants; 29 in Sweden, 93 in Europe, and 15 outside of Europe. Of the 132 participants that reported results, 39 (30 %) provided at least one result that received an annotation. In the previous PT round with similar analyses (January 2022) the proportion was 41 %.

Individual results are listed in Annex 1 and on the website: <https://www2.slv.se/absint>. Z-scores for individual results are listed in Annex 2.

**Table 1.** Composition of the test material and proportion of deviating results (N: number of reported results, F: false positive or false negative, X: outliers)

	Sample A				Sample B				Sample C			
% participants with												
	83%				84%				86%			
Microorganisms	<i>Campylobacter coli</i> <i>Citrobacter freundii</i> <i>Escherichia coli</i> O157 <i>Listeria monocytogenes</i> <i>Vibrio parahaemolyticus</i>				<i>Escherichia coli</i> <i>Kocuria rhizophila</i> <i>Salmonella</i> Stockholm <i>Yersinia enterocolitica</i>				<i>Escherichia coli</i> <i>Salmonella</i> Stockholm <i>Staphylococcus aureus</i> <i>Vibrio cholerae</i> <i>Yersinia enterocolitica</i>			
Analysis	Target organism	N	F	X	Target organism	N	F	X	Target organism	N	F	X
Aerobic micro-organisms, 30 °C	<i>C. freundii</i> <i>E. coli</i> O157	110	0	4	<i>K. rhizophila</i> <i>E. coli</i>	110	0	4	<i>S. aureus</i> <i>E. coli</i>	110	0	7
Enterobacteriaceae	<i>C. freundii</i> <i>E. coli</i> O157	95	1	8	<i>E. coli</i>	95	0	8	<i>E. coli</i>	95	0	3
Thermotol. <i>Campylobacter</i> – Quantitative	<i>C. coli</i>	15	2	0	( <i>E. coli</i> )	15	1	0	( <i>E. coli</i> )	15	1	0
<i>L. monocytogenes</i> – Quantitative	<i>L. monocytogenes</i>	56	0	6	-	58	1	0	-	58	0	0
Thermotol. <i>Campylobacter</i> – Qualitative	<i>C. coli</i>	20	2	-	( <i>E. coli</i> )	20	2	-	( <i>E. coli</i> )	20	2	-
<i>L. monocytogenes</i> – Qualitative	<i>L. monocytogenes</i>	91	0	-	-	91	0	-	-	91	0	-
<i>Salmonella</i>	( <i>C. freundii</i> )	101	0	-	<b>S. Stockholm</b>	101	2	-	<b>S. Stockholm</b>	101	0	-
<i>E. coli</i> O157	<i>E. coli</i> O157	23	5	-	( <i>E. coli</i> )	23	5	-	( <i>E. coli</i> )	23	5	-
Pathogenic <i>Vibrio</i> spp.	<i>V. parahaemolyticus</i>	18	1	-	-	18	0	-	<i>V. cholerae</i>	18	2	-
<i>Y. enterocolitica</i>	( <i>C. freundii</i> )	11	0	-	<i>Y. enterocolitica</i>	11	2	-	<i>Y. enterocolitica</i>	11	0	-

- no target organism or no value; **microorganism** = main target organism; (*microorganism*) = false positive before confirmation

■ The results are not evaluated

# Aerobic microorganisms, 30 °C

## Sample A

All strains in the sample were target organisms. *C. freundii* was present in considerably higher concentration than the other strains.

In total, 110 participants reported results. Three low and one high outliers were reported.

The results for Petrifilm AC were on average 1 <sub>SPT</sub> higher than <sub>MPT</sub>. All results from participants that used Petrifilm AC were however well within the acceptance limits.

## Sample B

All strains in the sample were target organisms. The strains of *E. coli* and *K. rhizophila* were present in considerably higher concentrations than the other strains.

In total, 110 participants reported results. Three low and one high outliers were reported.

## Sample C

All strains in the sample were target organisms. The strains of *E. coli* and *S. aureus* were present in considerably higher concentrations than the other strains.

In total, 110 participants reported results. Five low and two high outliers were reported.

## General remarks

The majority of the participants followed either NMKL 86:2013 or ISO 4833-1:2013, and thus incubated on PCA. Petrifilm AC was also used by a large number of participants. MPCA was mainly used by participants within the dairy industry, whereas incubation on TSA was mainly done by users of a company-specific method. ISO 4833-1:2013 was last reviewed by ISO in 2019 and remains current. NMKL 86:2013 was last reviewed by NMKL in 2022 and remains current.

**Comment:** One participant followed ISO 13559/IDF 153 (contaminating microorganisms). Since ISO 13559 uses a comparable incubation, and since the participant incubated on PCA, the results were still included in the evaluation.

**Table 2.** Results from analysis of aerobic microorganisms, 30 °C.

Medium	Sample A							Sample B							Sample C						
	N	n	m	s	F	<	>	N	n	m	s	F	<	>	N	n	m	s	F	<	>
<b>All results</b>	<b>110</b>	<b>106</b>	<b>3.64</b>	<b>0.27</b>	<b>0</b>	<b>3</b>	<b>1</b>	<b>110</b>	<b>106</b>	<b>4.49</b>	<b>0.24</b>	<b>0</b>	<b>3</b>	<b>1</b>	<b>110</b>	<b>103</b>	<b>4.62</b>	<b>0.13</b>	<b>0</b>	<b>5</b>	<b>2</b>
PCA	58	55	3.51	0.22	0	3	0	58	56	4.51	0.19	0	2	0	58	54	4.59	0.13	0	4	0
Petrifilm AC	22	22	3.92	0.12	0	0	0	22	22	4.39	0.26	0	0	0	22	21	4.65	0.10	0	0	1
TSA	10	10	3.83	0.12	0	0	0	10	10	4.67	0.29	0	0	0	10	10	4.66	0.08	0	0	0
TEMPO AC	7	7	3.68	0.21	0	0	0	7	7	4.62	0.20	0	0	0	7	7	4.68	0.11	0	0	0
TGE	4	3	-	-	0	0	1	4	3	-	-	0	0	1	4	3	-	-	0	0	1
MPCA	4	4	-	-	0	0	0	4	4	-	-	0	0	0	4	4	-	-	0	0	0
Other	3	3	-	-	0	0	0	3	2	-	-	0	1	0	3	2	-	-	0	1	0
Compact Dry TC	2	2	-	-	0	0	0	2	2	-	-	0	0	0	2	2	-	-	0	0	0

For "All results", m = robust  $m_{PT}$  and s = robust  $s_{PT}$ .

For individual media, m = mean value and s = standard deviation for the particular medium (outliers and false results excluded).

<sup>1</sup> "Petrifilm AC" includes one participant that incubated on Petrifilm RAC.

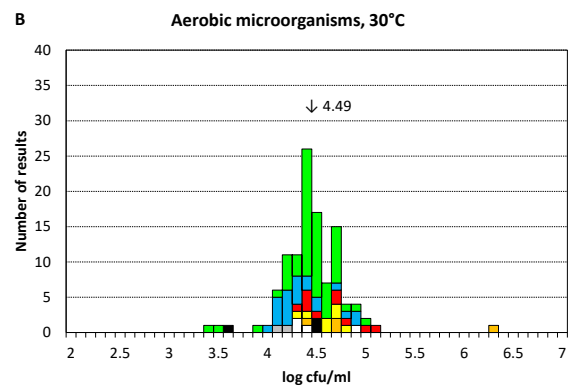
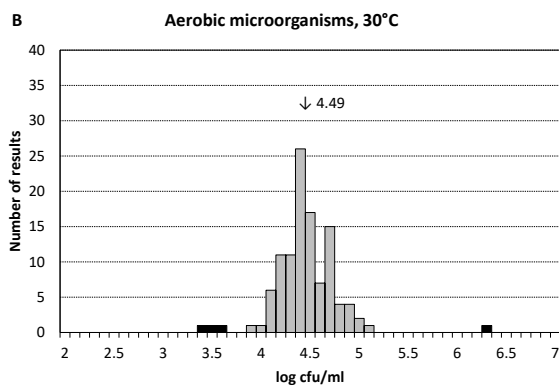
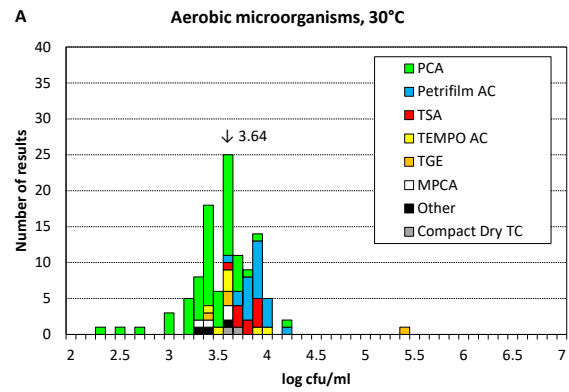
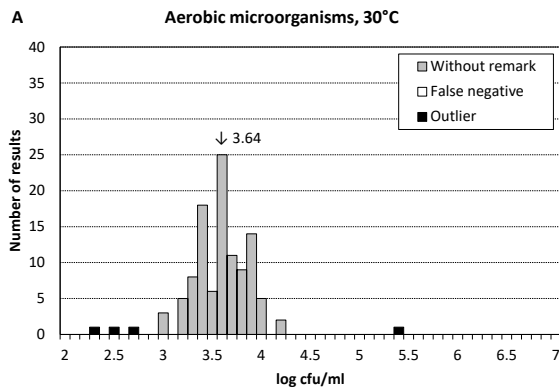

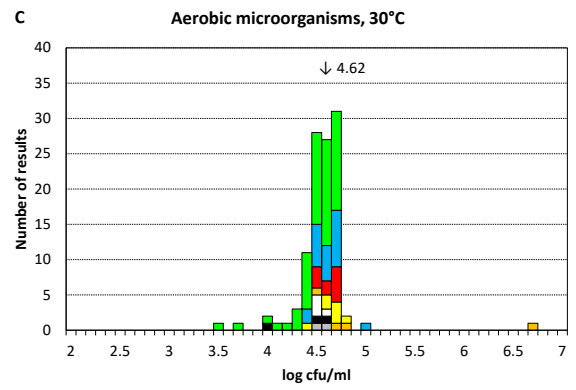
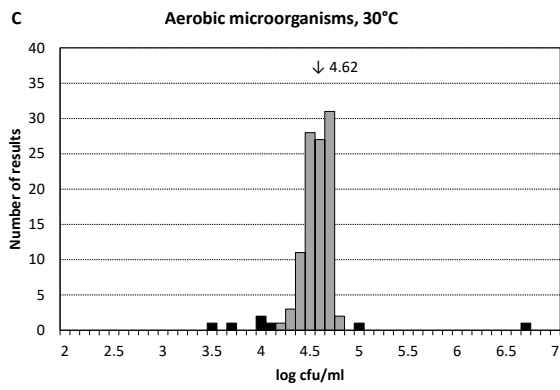

Figure 1. Results from analysis of aerobic microorganisms, 30 °C.

# Enterobacteriaceae

## Sample A

*C. freundii* and *E. coli* O157 belong to Enterobacteriaceae. *C. freundii* was present in considerably higher concentration than *E. coli* O157 and was thus the main target organism. On VRBG, *C. freundii* forms typical red colonies surrounded by a bile salt precipitation zone. The strain is oxidase-negative.

In total, 95 participants reported results. Six low and two high outliers were reported, as well as one false negative result.

## Sample B

The strain of *E. coli* (identical to that in sample C) was target organism. On VRBG, it forms typical red/purple colonies surrounded by a precipitation zone. The strain is oxidase-negative.

In total, 95 participants reported results. One low and seven high outliers were reported.

## Sample C

The strain of *E. coli* (identical to that in sample B) was target organism. On VRBG, it forms typical red/purple colonies surrounded by a precipitation zone. The strain is oxidase-negative.

In total, 95 participants reported results. One low and two high outliers were reported.

## General remarks

Enterobacteriaceae are Gram-negative and oxidase-negative bacteria that ferment glucose with the production of acid by-products. On VRBG they therefore form pink/red colonies, with or without a bile salt precipitation zone. The appearance is similar on Petrifilm EB, which also includes a colour indicator for acid by-products and a plastic film for detection of gas production.

The most common methods were NMKL 144:2005 (42 participants) or a method with Petrifilm EB (22 participants). Nine participants followed ISO 21528-2:2017. Three and four participants followed the withdrawn ISO 21528-2:2004 and ISO 21528-1:2004, respectively. ISO 21528-2:2017 is based on colony-count, whereas ISO 21528-1:2017 is based on MPN. The latter method is recommended when the expected level of Enterobacteriaceae is lower than 100 cfu g<sup>-1</sup>. Both ISO standards were last reviewed by ISO in 2022 and remain current.

Confirmation was performed by 65 % of the participants, and most often consisted of an oxidase test.

**Table 3.** Results from analysis of Enterobacteriaceae.

Medium	Sample A							Sample B							Sample C						
	N	n	m	s	F	<	>	N	n	m	s	F	<	>	N	n	m	s	F	<	>
<b>All results</b>	<b>95</b>	<b>86</b>	<b>3.38</b>	<b>0.27</b>	<b>1</b>	<b>6</b>	<b>2</b>	<b>95</b>	<b>87</b>	<b>4.18</b>	<b>0.16</b>	<b>0</b>	<b>1</b>	<b>7</b>	<b>95</b>	<b>92</b>	<b>4.04</b>	<b>0.23</b>	<b>0</b>	<b>1</b>	<b>2</b>
VRBG	58	51	3.36	0.24	0	5	2	58	55	4.15	0.14	0	0	3	58	55	3.98	0.22	0	1	2
Petrifilm EB	22	21	3.50	0.15	1	0	0	22	19	4.17	0.11	0	0	3	22	22	4.13	0.20	0	0	0
TEMPO EB	8	8	3.38	0.33	0	0	0	8	7	4.28	0.16	0	0	1	8	8	4.04	0.39	0	0	0
TSA/VRBG	3	3	-	-	0	0	0	3	3	-	-	0	0	0	3	3	-	-	0	0	0
Compact Dry EYB	2	1	-	-	0	1	0	2	2	-	-	0	0	0	2	2	-	-	0	0	0
Other	2	2	-	-	0	0	0	2	1	-	-	0	1	0	2	2	-	-	0	0	0

For "All results", m = robust  $m_{PT}$  and s = robust  $s_{PT}$ .

For individual methods, m = mean value and s = standard deviation for the particular method (outliers and false results excluded).

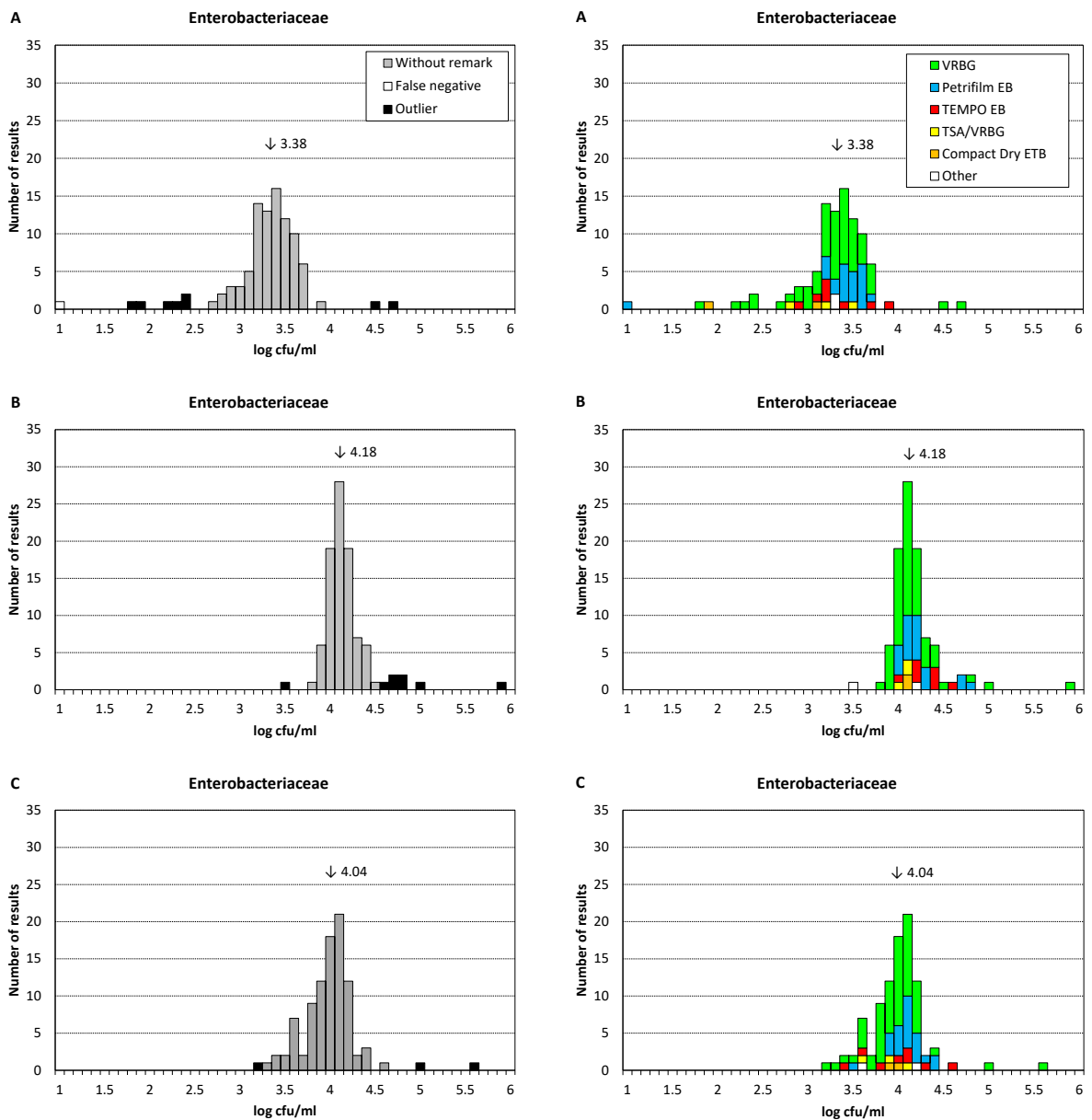

**Figure 2.** Results from analysis of Enterobacteriaceae.



# Thermotolerant *Campylobacter*

## Sample A

The strain of *C. coli* was target organism. On mCCDA it may possibly form both smaller and larger colonies. The strain is oxidase-positive and catalase-positive. It is also positive for the hydrolysis of indoxyl acetate, negative for the hydrolysis of hippurate, and has a for *Campylobacter* typical appearance under a microscope.

In the quantitative analysis, 15 participants reported results. Due to the low number of participants, and the high measurement uncertainty of the assigned value, all positive results are considered correct. Two false negative results were reported.

In the qualitative analysis, 20 participants reported results. Of these, two reported a false negative result.

## Sample B

No target organism was present in the sample. *E. coli* is however false positive for the analysis and may form atypical white/grey colonies on mCCDA. The strain is oxidase-negative and catalase-positive. It is easily distinguished from *Campylobacter* under a microscope.

In the quantitative analysis, 15 participants reported results. Of these, one reported a false positive result.

In the qualitative analysis, 20 participants reported results. Of these, two reported a false positive result.

## Sample C

No target organism was present in the sample. *E. coli* is however false positive for the analysis. It may form atypical white/grey colonies on mCCDA. The strain is oxidase-negative and catalase-positive. It is easily distinguished from *Campylobacter* under a microscope.

In the quantitative analysis, 15 participants reported results. Of these, one reported a false positive result.

In the qualitative analysis, 20 participants reported results. Of these, two reported a false positive result.

## General remarks

*Campylobacter* spp. are gram-negative, oxidase-positive and catalase-positive bacteria. On mCCDA they normally form flat or convex colonies, with a grey/white colour and a glossy surface. Confirmation is often done with an oxidase test or a catalase test, or phenotypically by microscopy. The bacteria normally have a spiral morphology, and display characteristic darting or corkscrew-like movements. In addition, *C. jejuni*, *C. coli* and *C. lari* can be separated by differences in their hydrolysis of hippurate and indoxyl acetate, and their sensitivity/resistance to nalidixic acid and cephalothin. Confirmation of some kind was performed in both the quantitative and qualitative analysis by all except one participant. The most common types of confirmation were a motility test and/or an oxidase test, but a catalase test was also fairly common.

NMKL 119:2007 (qualitative/quantitative), ISO 10272-1:2017 (qualitative) and ISO 10272-2:2017 (quantitative) were the most common methods. In the qualitative analysis, one participant followed the withdrawn ISO 10272-1:2006. Also in the qualitative analysis, one participant followed ISO 17995, which is a method for detection of *Campylobacter* in water samples.

In the qualitative analysis, the majority of the participants (80 %) used Bolton broth for the enrichment, but the use of Preston broth and CampyFood® was also reported. For the selective step, most participants (80 %) used mCCDA, but CampyFood®, Brilliance™ CampyCount agar and Abeyta-Hunt Bark agar were also used.

Similarly, in the quantitative analysis, 80 % of the participants incubated on mCCDA. TEMPO®CAM, RAPID'Campylobacter and Abeyta-Hunt Bark agar were used by one participant each.

**Table 4.** Results from quantitative analysis of thermotolerant *Campylobacter*.

Method	Sample A							Sample B							Sample C						
	N	n	m	s	F	<	>	N	n	m	s	F	<	>	N	n	m	s	F	<	>
<b>All results</b>	<b>15</b>	<b>13</b>	<b>1.38</b>	<b>0.28</b>	<b>2</b>	<b>0</b>	<b>0</b>	<b>15</b>	<b>14</b>	-	-	<b>1</b>	-	-	<b>15</b>	<b>14</b>	-	-	<b>1</b>	-	-
ISO 10272-2:2017	9	8	1.46	0.38	1	0	0	9	8	-	-	1	-	-	9	8	-	-	1	-	-
NMKL 119:2007	5	4	-	-	1	0	0	5	5	-	-	0	-	-	5	5	-	-	0	-	-
TEMPO	1	1	-	-	0	0	0	1	1	-	-	0	-	-	1	1	-	-	0	-	-

For "All results", m = robust m<sub>PT</sub> and s = robust s<sub>PT</sub>.

For individual methods, m = median value and s = standard deviation for the particular method (outliers and false results excluded).

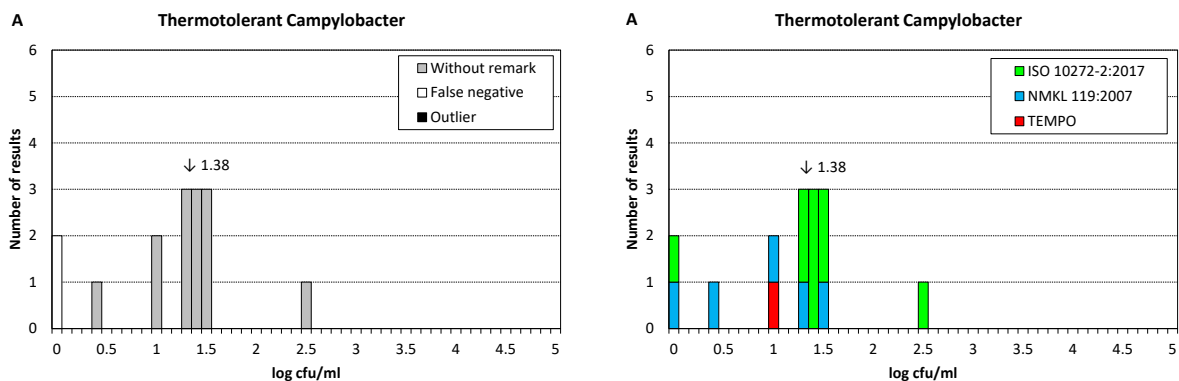

**Figure 3.** Results from quantitative analysis of thermotolerant *Campylobacter*.

**Table 5.** Results from qualitative analysis of thermotolerant *Campylobacter*.

Method	Sample A							Sample B							Sample C						
	N	n	m	s	F	<	>	N	n	m	s	F	<	>	N	n	m	s	F	<	>
<b>All results</b>	<b>20</b>	<b>18</b>	-	-	<b>2</b>	-	-	<b>20</b>	<b>18</b>	-	-	<b>2</b>	-	-	<b>20</b>	<b>18</b>	-	-	<b>2</b>	-	-
NMKL 119:2007	9	9	-	-	0	-	-	9	9	-	-	0	-	-	9	9	-	-	0	-	-
ISO 10272-1:2017	6	4	-	-	2	-	-	6	4	-	-	2	-	-	6	4	-	-	2	-	-
VIDAS	3	3	-	-	0	-	-	3	3	-	-	0	-	-	3	3	-	-	0	-	-
ISO 17995	1	1	-	-	0	-	-	1	1	-	-	0	-	-	1	1	-	-	0	-	-
ISO 10272-1:2006	1	1	-	-	0	-	-	1	1	-	-	0	-	-	1	1	-	-	0	-	-

# *Listeria monocytogenes*

## Sample A

The strain of *L. monocytogenes* was target organism. On ALOA it forms characteristic blue-green colonies, surrounded by a distinct opaque halo after 48 hours. On PALCAM it forms characteristic grey-green colonies surrounded by a black/brown zone after 48 hours. The strain is motile, catalase-positive, displays  $\beta$ -haemolysis on blood agar, and ferments rhamnose but not xylose.

In the quantitative analysis, 56 participants reported results. Three low and three high outliers were reported.

In the qualitative analysis, 91 participants reported results. All reported results were correct positive.

## Sample B

No target organism was present in the sample.

In the quantitative analysis, 58 participants reported results. Of these, one reported a false positive result.

In the qualitative analysis, 91 participants reported results. All reported results were correct negative.

## Sample C

No target organism was present in the sample.

In the quantitative analysis, 58 participants reported results. All reported results were correct negative.

In the qualitative analysis, 91 participants reported results. All reported results were correct negative.

## General remarks

ISO 11290-2 (different versions), NMKL 136:2010 and RAPID'L.mono were the main methods used in the quantitative analysis. In contrast, in the qualitative analysis, RAPID'L.mono, VIDAS® and different versions of ISO 11290-1 were the most common. ISO 11290-1:2017 and ISO 11290-2:2017 were last reviewed by ISO in 2022, and remain current.

NMKL 136:2010 describes both detection and enumeration of *L. monocytogenes*. In comparison, ISO 11290-1:2017 (qualitative) and ISO 11290-2:2017 (quantitative) detect/enumerate both *Listeria* spp. and *L. monocytogenes*. All of these methods mainly use ALOA for the isolation, on which *L. monocytogenes* form blue-green colonies due to  $\beta$ -glucosidase activity. The colonies are also surrounded by an opaque halo due to hydrolysis of inositol in the medium. The halo is sometimes weak, or may not be present at all. RAPID'L.mono is based on a chromogenic medium that identifies the enzyme PI-PLC in *L. monocytogenes*. It identifies both *Listeria* spp. and *L. monocytogenes* based on their inability to metabolise xylose. Similarly, Listeria Precis™ is based on the chromogenic medium Brilliance™ Listeria, on which *Listeria* spp. and *L. monocytogenes* form blue colonies due to their  $\beta$ -glucosidase activity. SwabSURE ListeriaP is a test based on swab sampling, for detection of *L. monocytogenes* and *L. ivanovii* in surface samples. In comparison, VIDAS® is based on detection of

specific *L. monocytogenes* antigen, in a method based on ELFA (*Enzyme Linked Fluorescent Assay*). Different variants of the VIDAS® method exist for *Listeria* spp. and/or *Listeria monocytogenes*. The alternative methods are all validated by AFNOR and/or NordVal.

*L. monocytogenes* is often confirmed by microscopy, catalase test, and by tests of  $\beta$ -haemolysis and carbohydrate utilisation (fermentation of rhamnose and xylose). *L. monocytogenes* is catalase-positive, displays  $\beta$ -haemolysis on blood agar, and ferments rhamnose but not xylose. Confirmation can also be done by the increased and decreased  $\beta$ -haemolysis displayed by *L. monocytogenes* in the presence of *Staphylococcus aureus* and *Rhodococcus equi*, respectively (CAMP test).

**Table 6.** Results from quantitative analysis of *Listeria monocytogenes*.

Method	Sample A							Sample B							Sample C						
	N	n	m	s	F	<	>	N	n	m	s	F	<	>	N	n	m	s	F	<	>
<b>All results</b>	<b>56</b>	<b>50</b>	<b>2.44</b>	<b>0.10</b>	<b>0</b>	<b>3</b>	<b>3</b>	<b>58</b>	<b>57</b>	-	-	<b>1</b>	-	-	<b>58</b>	<b>58</b>	-	-	<b>0</b>	-	-
ISO 11290-2:2017	17	17	2.47	0.07	0	0	0	17	17	-	-	0	-	-	17	17	-	-	0	-	-
RAPID'L.mono	15	14	2.38	0.08	0	0	1	15	15	-	-	0	-	-	15	15	-	-	0	-	-
NMKL 136:2010	15	12	2.42	0.08	0	2	1	15	15	-	-	0	-	-	15	15	-	-	0	-	-
ISO 11290-2:1998/Amd 1:2004	4	4	-	-	0	0	0	5	4	-	-	1	-	-	5	5	-	-	0	-	-
Listeria Precis™	4	3	-	-	0	1	0	4	4	-	-	0	-	-	4	4	-	-	0	-	-
VIDAS® LMX	1	0	-	-	0	0	1	2	2	-	-	0	-	-	2	2	-	-	0	-	-

For "All results", m = robust  $m_{PT}$  and s = robust  $s_{PT}$ .

For individual methods, m = mean value and s = standard deviation for the particular method (outliers and false results excluded).

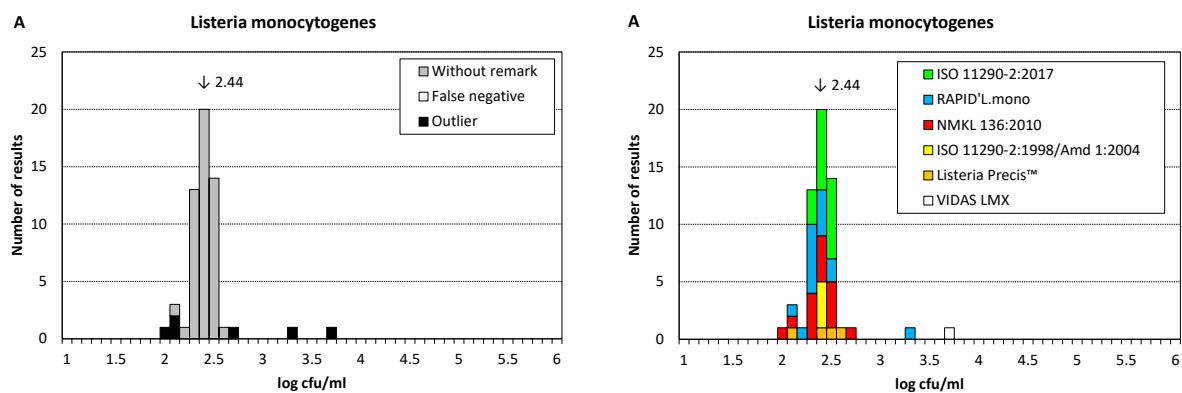

**Figure 4.** Results from analysis of *Listeria monocytogenes*.

**Table 7.** Results from qualitative analysis of *Listeria monocytogenes*.

Method	Sample A							Sample B							Sample C						
	N	n	m	s	F	<	>	N	n	m	s	F	<	>	N	n	m	s	F	<	>
<b>All results</b>	<b>91</b>	<b>91</b>	-	-	<b>0</b>	-	-	<b>91</b>	<b>91</b>	-	-	<b>0</b>	-	-	<b>91</b>	<b>91</b>	-	-	<b>0</b>	-	-
RAPID'L.mono	19	19	-	-	0	-	-	19	19	-	-	0	-	-	19	19	-	-	0	-	-
VIDAS®	17	17	-	-	0	-	-	17	17	-	-	0	-	-	17	17	-	-	0	-	-
PCR	12	12	-	-	0	-	-	12	12	-	-	0	-	-	12	12	-	-	0	-	-
ISO 11290-1:2017	11	11	-	-	0	-	-	11	11	-	-	0	-	-	11	11	-	-	0	-	-
NMKL 136:2010	10	10	-	-	0	-	-	10	10	-	-	0	-	-	10	10	-	-	0	-	-
Other	9	9	-	-	0	-	-	9	9	-	-	0	-	-	9	9	-	-	0	-	-
ISO 11290-1:1996/Amd 1:2004	6	6	-	-	0	-	-	6	6	-	-	0	-	-	6	6	-	-	0	-	-
Listeria Precis™	3	3	-	-	0	-	-	3	3	-	-	0	-	-	3	3	-	-	0	-	-
SwabSURE ListeriaP	2	2	-	-	0	-	-	2	2	-	-	0	-	-	2	2	-	-	0	-	-
IDF 143A:1995	1	1	-	-	0	-	-	1	1	-	-	0	-	-	1	1	-	-	0	-	-
iQ-Check Listeria monocytogenes II	1	1	-	-	0	-	-	1	1	-	-	0	-	-	1	1	-	-	0	-	-

# Salmonella

## Sample A

No target organism was present in the sample. In the quality control at the Swedish Food Agency, *C. freundii* formed white colonies on XLD and transparent colonies on Brilliance™ Salmonella.

In total, 101 participants reported results. All reported results were correct negative.

## Sample B

The strain of *S. Stockholm* (identical to that in sample C) was target organism. In this sample, it was present in a low concentration, approximately 6 cfu ml<sup>-1</sup>. On XLD, it forms typical red colonies with a black centre. On Brilliance™ Salmonella, it forms typical purple colonies. The strain is positive for agglutination against both O and H antigen.

In total, 101 participants reported results. Of these, two reported a false negative result. The two participants analysed with a VIDAS® method, which should be able to detect *Salmonella* at the level present in sample B.

## Sample C

The strain of *S. Stockholm* (identical to that in sample B) was target organism. On XLD, it forms typical red colonies with a black centre. On Brilliance™ Salmonella, it forms typical purple colonies. The strain is positive for agglutination against both O and H antigen.

In total, 101 participants reported results. All reported results were correct positive.

## General remarks

The two most common methods were NMKL 71:1999 and ISO 6579-1:2017, which are very similar. Both are based on pre-incubation in BPW, followed by selective enrichment in RVS. ISO 6579-1:2017 also includes selective enrichment in MKTTn. With the ISO method, RVS can also be substituted with semi-solid MSR/V for the analysis of motile *Salmonella*. With both methods, incubation is mainly on XLD, and confirmation is by biochemical (e.g. mannitol and urea) and serological (e.g. *Salmonella* polyvalent O and H antisera) tests. ISO 6579-1:2017 was last reviewed by ISO in 2022, and remains current.

Other common methods used by the participants were VIDAS® SPT and RAPID® Salmonella. Both are validated by AFNOR and AOAC against ISO 6579-1:2017. PCR-based methods were also frequently used. The withdrawn methods ISO 6579:2002/Amd 1:2007 and ISO 6579:2002 were followed by three and four participants, respectively.

Users of NMKL methods can in addition to NMKL 71:1999 also choose to follow NMKL 187:2016. The latter method is intended for detection of motile *Salmonella* and, similarly to ISO 6579-1:2017, uses MSR/V instead of RVS during the selective enrichment step.

On XLD, which was used by the majority of the participants, typical *Salmonella* form transparent red colonies with a black centre. As a complementary medium to XLD, the participants mainly used chromogenic media such as Brilliance™ Salmonella or BGA.

**Table 8.** Results from analysis of *Salmonella*.

Method	Sample A							Sample B							Sample C						
	N	n	m	s	F	<	>	N	n	m	s	F	<	>	N	n	m	s	F	<	>
<b>All results</b>	<b>101</b>	<b>101</b>	-	-	<b>0</b>	-	-	<b>101</b>	<b>99</b>	-	-	<b>2</b>	-	-	<b>101</b>	<b>101</b>	-	-	<b>0</b>	-	-
NMKL 71:1999	27	27	-	-	0	-	-	27	27	-	-	0	-	-	27	27	-	-	0	-	-
ISO 6579-1:2017	19	19	-	-	0	-	-	19	19	-	-	0	-	-	19	19	-	-	0	-	-
VIDAS® SPT <sup>1</sup>	15	15	-	-	0	-	-	15	13	-	-	2	-	-	15	15	-	-	0	-	-
PCR method	13	13	-	-	0	-	-	13	13	-	-	0	-	-	13	13	-	-	0	-	-
Other	9	9	-	-	0	-	-	9	9	-	-	0	-	-	9	9	-	-	0	-	-
RAPID'Salmonella	7	7	-	-	0	-	-	7	7	-	-	0	-	-	7	7	-	-	0	-	-
ISO 6579:2002	4	4	-	-	0	-	-	4	4	-	-	0	-	-	4	4	-	-	0	-	-
ISO 6579:2002/Amd 1:2007	3	3	-	-	0	-	-	3	3	-	-	0	-	-	3	3	-	-	0	-	-
NMKL 187:2016 <sup>2</sup>	3	3	-	-	0	-	-	3	3	-	-	0	-	-	3	3	-	-	0	-	-
iQ-Check Salmonella II	1	1	-	-	0	-	-	1	1	-	-	0	-	-	1	1	-	-	0	-	-

<sup>1</sup> The group VIDAS includes two participants that used MINI VIDAS®.

<sup>2</sup> Includes both NMKL 187:2007 and NMKL 187:2016.

# *Escherichia coli* O157

## Sample A

The strain of *E. coli* O157 was target organism for the analysis. On CT-SMAC, it forms typical sorbitol-negative transparent colonies with a dark centre. The strain is positive for production of indole and for agglutination with *E. coli* O157 antiserum. It contains the gene *eae*, but no *stx* genes.

In total, 23 participants reported results. Of these, five reported a false negative result.

## Sample B

No target organism was present in the sample. The false-positive strain of *E. coli* may however form pink/red colonies on SMAC.

In total, 23 participants reported results. Of these, five reported a false positive result.

## Sample C

No target organism was present in the sample. In the Swedish Food Agency's quality control, the false-positive strain of *E. coli* formed red colonies on SMAC. No colonies were observed on CT-SMAC.

In total, 23 participants reported results. Of these, five reported a false positive result.

## General remarks

Only 23 participants reported evaluated results, and many of the reported methods fall into the group "Other" and "PCR method", which are in general not specified in detail. An assessment of the general performance is therefore challenging. Still, most false results appear to be due to the use of inappropriate methods.

Among the specified methods are NMKL 164:2005 and ISO 16654:2001, which are similar methods. Enrichment is done in mTSB with novobiocin, and is followed by immunomagnetic separation and isolation on CT-SMAC and another medium selected by the laboratory. Confirmation is by a test for indole production as well as agglutination with *E. coli* O157 antiserum. ISO 16654:2001 was last reviewed by ISO in 2018 and remains current. It has two published amendments; Amd 1:2017 and Amd 2:2023. The NMKL method is present in a new version, NMKL 164:2019. The major change from the previous edition is that presumptive *E. coli* O157 shall be sent to a reference/expert laboratory for determination of the virulence profile (*eae* and *stx* genes).

Notably, five participants reported incorrect results for all three samples. For three of these participants, the reason appears to be the use of an incorrect method for *E. coli* O157. Two participants reported following a TEMPO<sup>®</sup> method, presumably TEMPO<sup>®</sup> EC, which is adapted for the enumeration of *E. coli*. Another participant incubated on RAPID'E.coli 2 Agar which is also adapted for enumeration of *E. coli*. As it is unclear if additional confirmation tests for O157 were performed, the results are still included in the evaluation. The two remaining participants followed ISO 16654:2001, and should thus in theory have been able to identify *E. coli* O157. In this context it is worth noting that sample A



contained *E. coli* O157 in a low concentration, whereas samples B and C contained *E. coli* in high concentrations.

The most frequently specified media for isolation were CT-SMAC, SMAC and CHROMagar™ O157. CT-SMAC and SMAC distinguish between bacteria that ferment sorbitol (most non-pathogenic *E. coli*) are those that do not (most *E. coli* O157). On these media, sorbitol-negative *E. coli* O157 form transparent colonies with a dark centre, whereas sorbitol-positive *E. coli* instead form red colonies. Harlequin™ SMAC-BCIG is another medium that is sometimes used by participants. It is similar to SMAC, and contains the chromogenic substrate BGIC that causes sorbitol-negative and β-glucuronidase-positive *E. coli* to form blue/green colonies. In comparison, on CHROMagar™ *E. coli* O157 form mauve (purple) colonies that can be distinguished from coliform (blue) or other bacteria (colourless) that may grow on this medium.

**Comment:** The results from one participant were excluded from the evaluation, since the participant clearly specified that they only analysed for *E. coli*, and not for *E. coli* O157.

**Table 9.** Results from analysis of *Escherichia coli* O157.

Method	Sample A							Sample B							Sample C						
	N	n	m	s	F	<	>	N	n	m	s	F	<	>	N	n	m	s	F	<	>
<b>All results</b>	<b>23</b>	<b>18</b>	-	-	<b>5</b>	-	-	<b>23</b>	<b>18</b>	-	-	<b>5</b>	-	-	<b>23</b>	<b>18</b>	-	-	<b>5</b>	-	-
Other	8	5	-	-	3	-	-	8	5	-	-	3	-	-	8	5	-	-	3	-	-
PCR	5	5	-	-	0	-	-	5	5	-	-	0	-	-	5	5	-	-	0	-	-
NMKL 164:2005	3	3	-	-	0	-	-	3	3	-	-	0	-	-	3	3	-	-	0	-	-
ISO 16654:2001	3	1	-	-	2	-	-	3	1	-	-	2	-	-	3	1	-	-	2	-	-
ISO 16654:2001/Amd 1:2017	2	2	-	-	0	-	-	2	2	-	-	0	-	-	2	2	-	-	0	-	-
VIDAS® ECPT	2	2	-	-	0	-	-	2	2	-	-	0	-	-	2	2	-	-	0	-	-

# Pathogenic *Vibrio* spp.

## Sample A

The strain of *V. parahaemolyticus* was target organism. In the Swedish Food Agency's quality control, it formed typical green colonies on TCBS, after enrichment in alkaline peptone water with 2 % salt. No colonies were observed on TCBS after enrichment in salt polymyxin broth. The strain is oxidase-positive and sensitive to vibriostatic agent O129.

In total, 18 participants reported results. Of these, one reported a false negative result.

## Sample B

No target organism was present in the sample.

In total, 18 participants reported results. All reported a correct negative result.

## Sample C

The strain of *V. cholerae* was target organism. On TCBS, it forms typical green/yellow colonies. It is oxidase-positive and sensitive to vibriostatic agent O129. The strain of *E. coli* may form yellow and oxidase-negative colonies on TCBS. The strain of *S. Stockholm* may also form colonies on TCBS. All atypical colonies in the Swedish Food Agency's initial quality control on TCBS were oxidase-negative upon confirmation.

In total, 18 participants reported results. Of these, two reported a false negative result.

## General remarks

The majority of the 18 participants reported correct results. The false results were reported by participants that used methods that should allow them to correctly detect pathogenic *Vibrio* spp.

Most participants followed either NMKL 156:1997 or ISO 21872-1:2017. Three participants followed the withdrawn ISO/TS 21872-1:2007. ISO 21872-1:2017 was last reviewed by ISO in 2023 and remains current. It contains several changes, including how to perform confirmation with biochemical and/or PCR methods, though it mainly follows the same principle as the previous version. Primary and secondary enrichment in APW 2% is followed by inoculation onto TCBS. The procedure in NMKL 156:1997 is similar to ISO 21872-1:2017, but also includes enrichment in SP. In addition, the NMKL method only utilizes biochemical confirmation tests.

All except one participant isolated colonies on TCBS. Bile salts in TCBS inhibit the growth of Gram-positive microorganisms, whereas a high pH promotes the growth of *V. cholerae*. On TCBS, *Vibrio* spp. form either green or yellow colonies, depending on if they ferment sucrose or not. *V. parahaemolyticus* and *V. vulnificus* (sucrose-negative) normally form blue-green colonies, whereas *V. cholerae* (sucrose-positive) normally form yellow colonies.

**Table 10.** Results from analysis of pathogenic *Vibrio* spp.

Method	Sample A							Sample B							Sample C						
	N	n	m	s	F	<	>	N	n	m	s	F	<	>	N	n	m	s	F	<	>
<b>All results</b>	<b>18</b>	<b>17</b>	-	-	<b>1</b>	-	-	<b>18</b>	<b>18</b>	-	-	<b>0</b>	-	-	<b>18</b>	<b>16</b>	-	-	<b>2</b>	-	-
NMKL 156:1997	8	8	-	-	0	-	-	8	8	-	-	0	-	-	8	7	-	-	1	-	-
ISO 21872-1:2017	6	5	-	-	1	-	-	6	6	-	-	0	-	-	6	5	-	-	1	-	-
ISO/TS 21872-1:2007/Cor 1:2008	3	3	-	-	0	-	-	3	3	-	-	0	-	-	3	3	-	-	0	-	-
Other	1	1	-	-	0	-	-	1	1	-	-	0	-	-	1	1	-	-	0	-	-

# *Yersinia enterocolitica*

## Sample A

No target organism was present in the sample. The strain of *C. freundii* was however false positive for the analysis. In the Swedish Food Agency's quality control, it formed atypical pink colonies on CIN and yellow colonies on BS. The strain of *C. freundii* is oxidase-negative, and does not display agglutination against O:3 and O:9 antisera.

In total, 11 participants reported results. All reported a correct negative result.

## Sample B

The strain of *Y. enterocolitica* (identical to that in sample C) was target organism. On CIN, it forms typical colonies with a dark red centre, and an outer transparent zone. On BS, it forms typical yellow colonies. The strain is oxidase-negative, and displays agglutination against O:3 antiserum, but not against O:9 antiserum. The strain contains the gene *ail*.

In total, 11 participants reported results. Of these, two reported a false negative result.

## Sample C

The strain of *Y. enterocolitica* (identical to that in sample B) was target organism. On CIN, it forms typical colonies with a dark red centre, and an outer transparent zone. On BS, it forms typical yellow colonies. The strain is oxidase-negative, and displays agglutination against O:3 antiserum, but not against O:9 antiserum. The strain contains the gene *ail*.

In total, 11 participants reported results. All reported a correct positive result.

## General remarks

Most participants followed ISO 10273:2017. One participant followed the withdrawn 10273:2003. ISO 10273:2017 contains several important changes compared to the previous version. These include that characteristic *Y. enterocolitica* can be confirmed either by the traditional biochemical methods or by detection of the chromosomal virulence-associated gene *ail* by real-time PCR. It was last reviewed by ISO in 2022 and remains current.

One participant followed NMKL 117:1996. A revised version of this was published in 2022; NMKL 117:2022. The new method contains many changes compared to the previous version, and is aimed specifically at the detection of pathogenic bioserotypes of *Y. enterocolitica*.

All except one participant isolated colonies on CIN, in some cases in combination with another medium. On CIN, colonies of *Y. enterocolitica* have a typical appearance; a dark red "bull's eye" centre and an outer transparent zone.

One participant followed ISO/TS 18867:2015, which is PCR method for the detection of pathogenic *Y. enterocolitica* and *Y. pseudotuberculosis*. It was last reviewed by ISO in 2022 and remains current.

**Table 11.** Results from analysis of *Yersinia enterocolitica*.

Method	Sample A							Sample B							Sample C						
	N	n	m	s	F	<	>	N	n	m	s	F	<	>	N	n	m	s	F	<	>
<b>All results</b>	<b>11</b>	<b>11</b>	-	-	<b>0</b>	-	-	<b>11</b>	<b>9</b>	-	-	<b>2</b>	-	-	<b>11</b>	<b>11</b>	-	-	<b>0</b>	-	-
ISO 10273:2017	5	5	-	-	0	-	-	5	5	-	-	0	-	-	5	5	-	-	0	-	-
Other	2	2	-	-	0	-	-	2	1	-	-	1	-	-	2	2	-	-	0	-	-
NMKL 117:1996	1	1	-	-	0	-	-	1	1	-	-	0	-	-	1	1	-	-	0	-	-
ISO/TS 18867:2015	1	1	-	-	0	-	-	1	0	-	-	1	-	-	1	1	-	-	0	-	-
ISO 10273:2003	1	1	-	-	0	-	-	1	1	-	-	0	-	-	1	1	-	-	0	-	-
PCR method	1	1	-	-	0	-	-	1	1	-	-	0	-	-	1	1	-	-	0	-	-

# Outcome of the results of individual participants - assessment

## Reporting and evaluation of results

The results of all participants are listed in Annex 1, together with the minimum and maximum accepted values for each analytical parameter. Outliers and false results are highlighted in yellow and red, respectively, with bold font.

Participants are not grouped or ranked based on their results. The performance of an individual participant can be broadly assessed by the numbers of outliers and false results, and by the z-scores.

Information on the results processing and recommendations for follow-up work are given in the Scheme Protocol [2].

Samples for follow-up analyses can be ordered at: [www.livsmedelsverket.se/en/PT-extra](http://www.livsmedelsverket.se/en/PT-extra)

## Box plots and numbers of deviating results for each participant

Box plots are based on the z-scores listed in Annex 2, and give a comprehensive view of the performance of each participant. The range of z-scores is indicated by the size of the box and, for most participants, by lines and/or circles above and beneath the box. A small range of values, centred around zero, indicates that the results of the individual participant are in general close to  $m_{PT}$  for the different analyses. For each participant, the number of false results and outliers are also listed in the tables below the box plots.

Outliers are included in the figures after being calculated to z-scores in the same way as for other results. Correct results for qualitative analyses and correct negative results for quantitative analyses without target organism are given a z-score of 0. False results do not generate any z-scores, and are not included in “No. of results”.

The participant’s median value is illustrated by a horizontal line in the box. Each box includes 50 % of a participant’s results (25 % of the results above the median and 25 % of the results below the median). The remaining 50 % are illustrated by lines and circles outside the box. A circle is for technical reasons shown in the plot when a value deviates to certain degree\* from the other values. This does not by itself indicate that the value is an outlier.

Z-scores  $>+4$  and  $<-4$  are positioned at  $+4$  and  $-4$ , respectively, in the plot. The background is divided by lines and shaded fields to simplify identifying the range in which the results are located.

\*  $< [\text{lowest value in the box} - 1,5 \times (\text{highest value in the box} - \text{lowest value in the box})]$   
or  
 $> [\text{highest value in the box} + 1,5 \times (\text{highest value in the box} - \text{lowest value in the box})].$

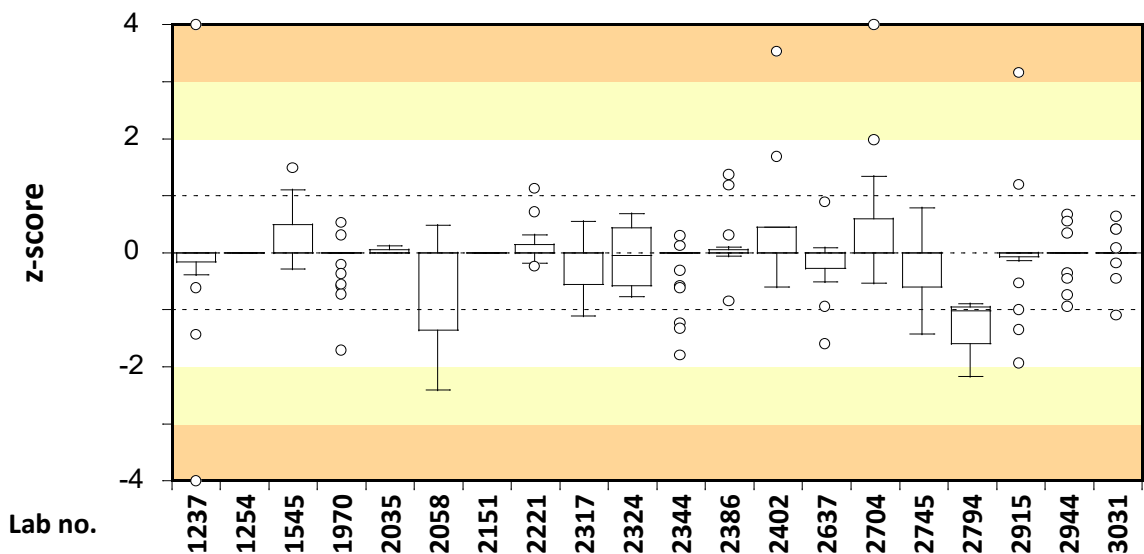

Lab no.	1237	1254	1545	1970	2035	2058	2151	2221	2317	2324	2344	2386	2402	2637	2704	2745	2794	2915	2944	3031
No. of results	24	6	15	27	3	12	9	15	15	6	30	15	9	15	15	15	3	20	18	18
False positive	2	0	0	0	0	0	2	0	0	0	0	0	0	0	0	0	0	0	0	0
False negative	2	0	0	1	0	1	1	0	0	0	1	0	0	0	0	0	0	0	0	0
Low outliers	1	0	0	0	0	0	0	0	0	0	0	0	0	0	0	0	0	0	0	0
High outliers	1	0	0	0	0	0	0	0	0	0	0	0	1	0	1	0	0	1	0	0

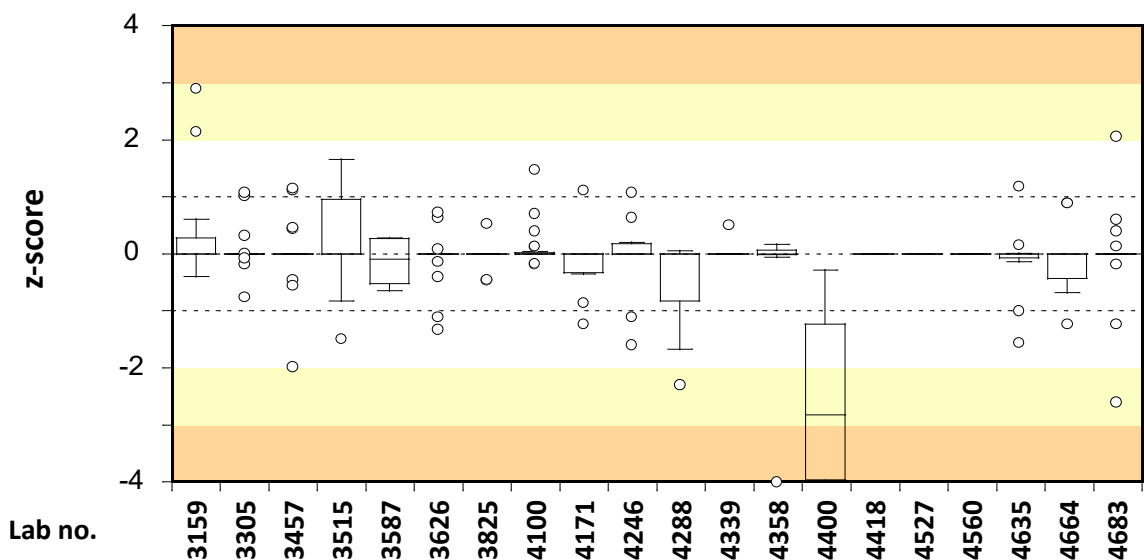

Lab no.	3159	3305	3457	3515	3587	3626	3825	4100	4171	4246	4288	4339	4358	4400	4418	4527	4560	4635	4664	4683
No. of results	15	18	18	15	6	21	12	24	12	12	12	12	9	6	0	3	3	12	18	24
False positive	0	0	0	2	0	0	0	0	0	0	0	0	0	0	0	0	0	0	0	2
False negative	0	0	0	1	0	1	0	0	0	0	0	0	0	0	0	1	0	0	0	2
Low outliers	0	0	0	0	0	0	0	0	0	0	0	0	1	3	0	0	0	0	0	0
High outliers	0	0	0	0	0	0	0	0	0	0	0	0	0	0	0	0	0	0	0	0

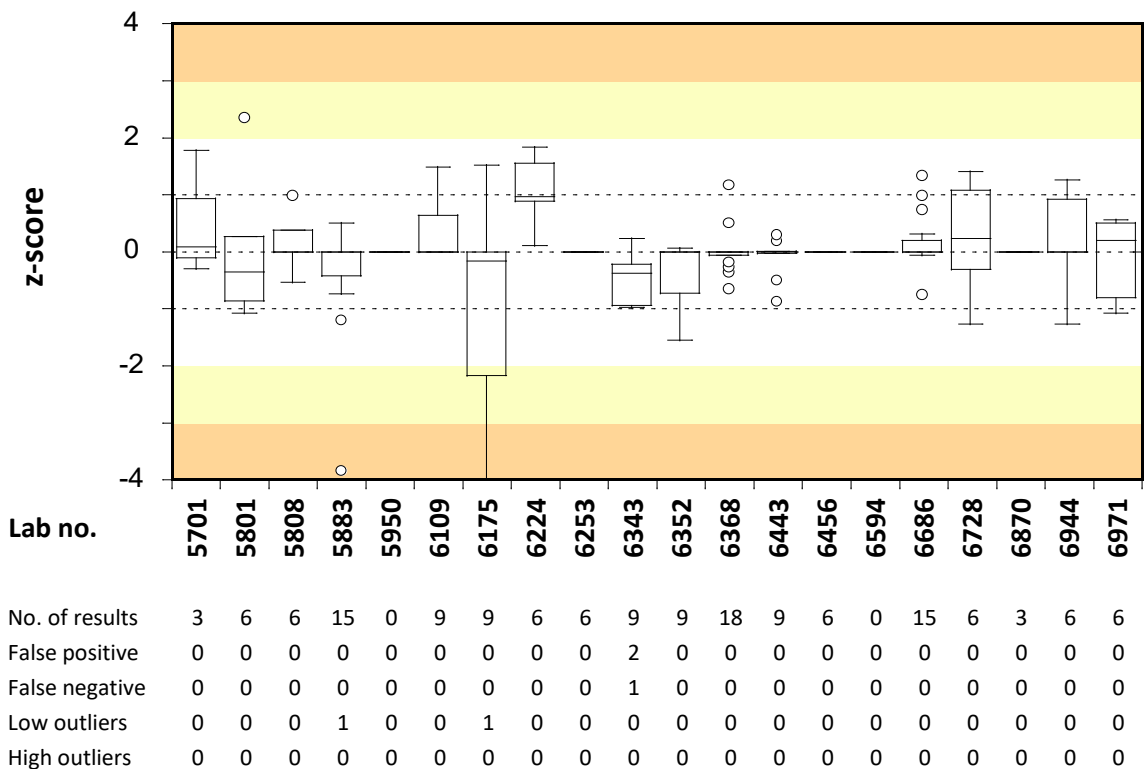
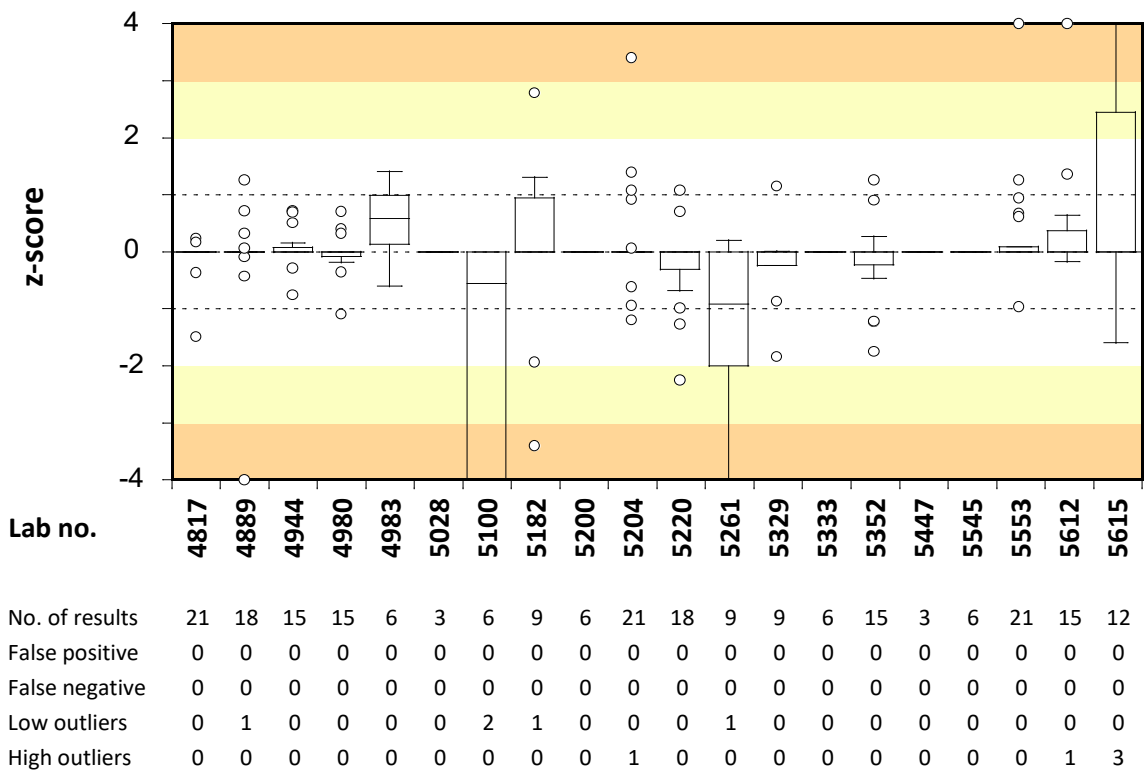



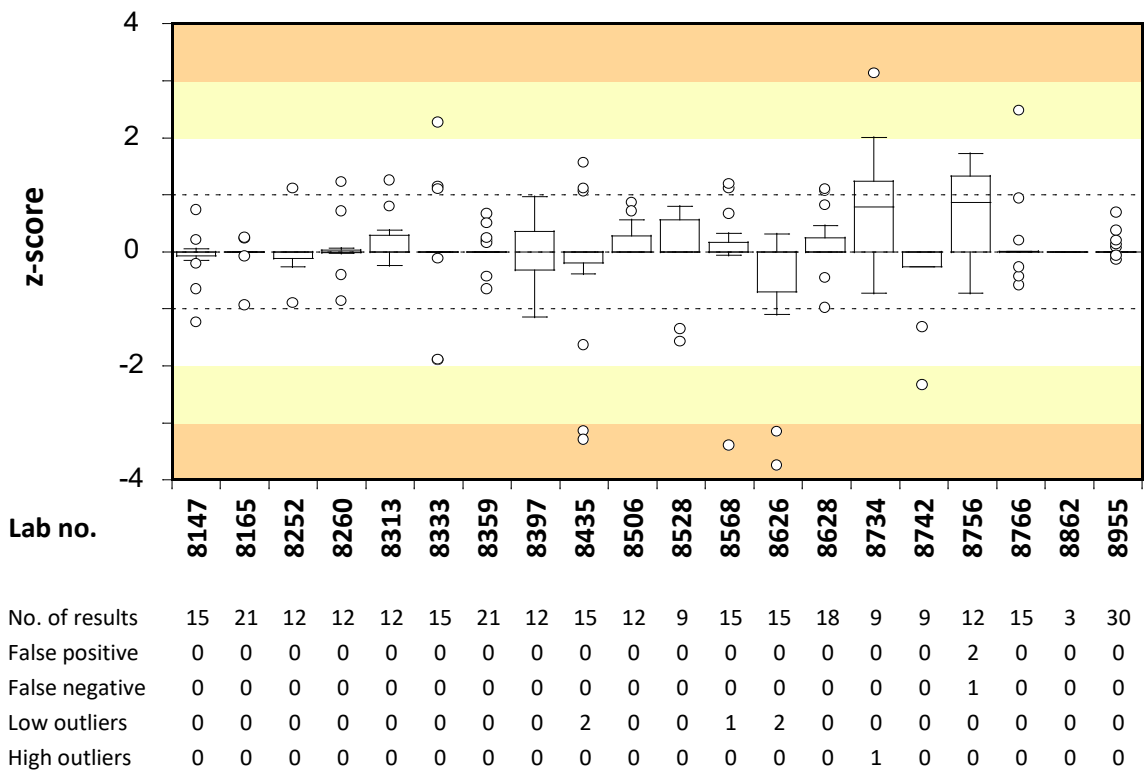
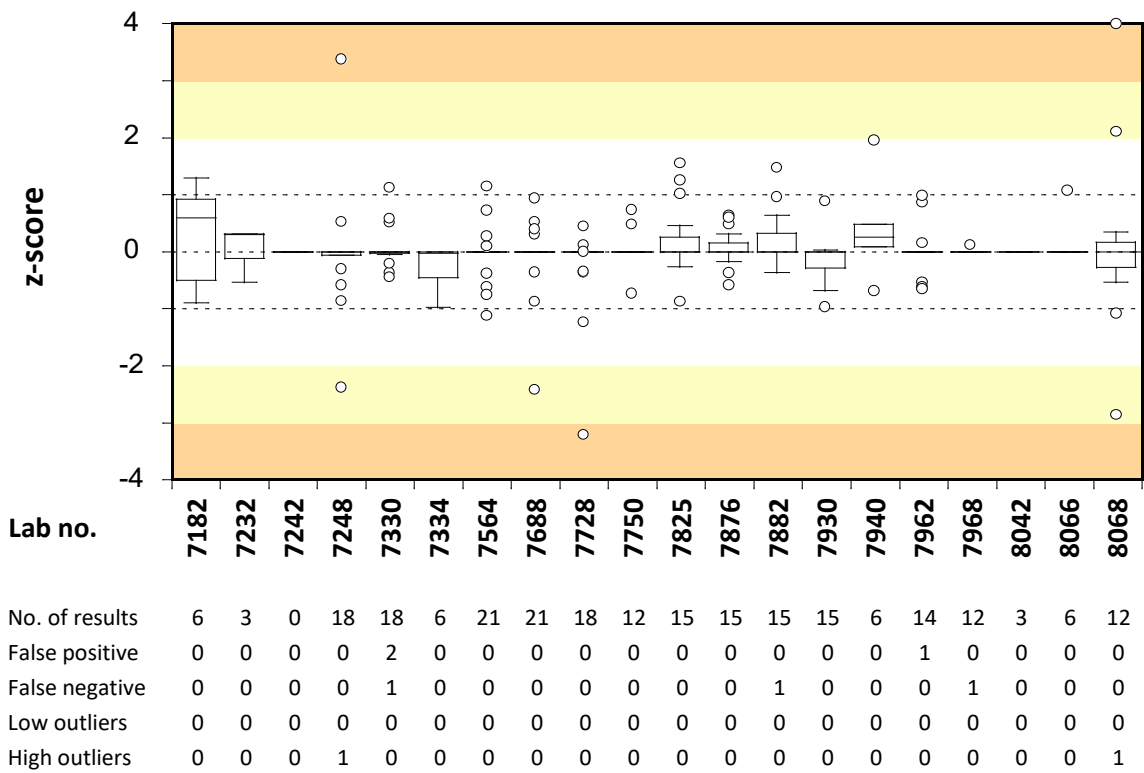

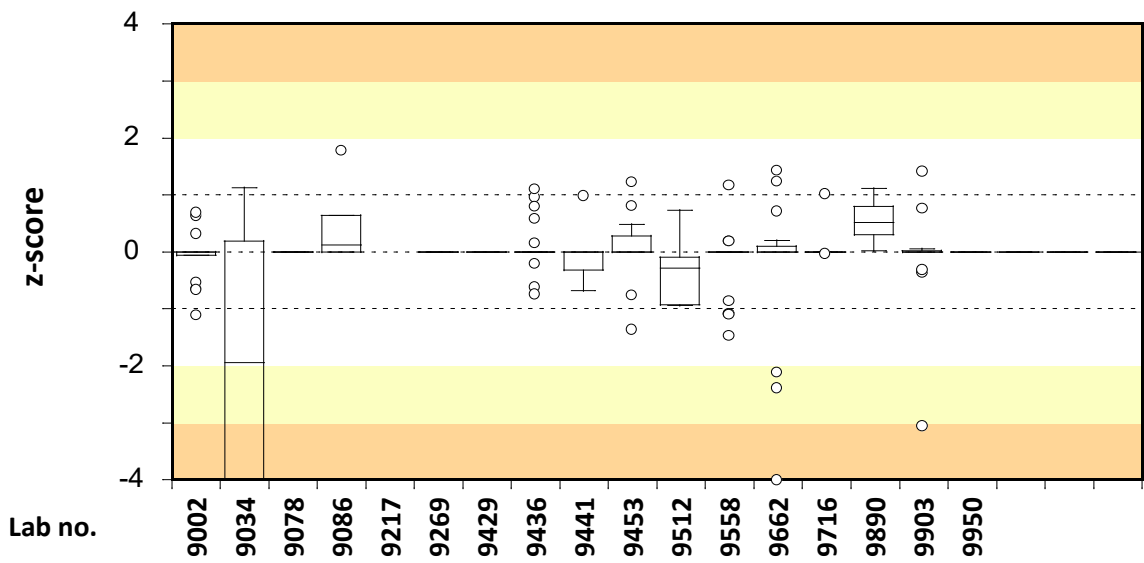

No. of results	18	6	0	6	9	3	6	21	15	12	6	30	15	12	6	15	3	0	0	0
False positive	0	0	0	0	2	0	0	0	0	0	0	0	0	0	0	0	0	0	0	0
False negative	0	0	0	0	1	0	0	0	0	0	0	0	0	0	0	0	0	0	0	0
Low outliers	0	3	0	0	0	0	0	0	0	0	0	0	1	0	0	1	0	0	0	0
High outliers	0	0	0	0	6	0	0	0	0	0	0	0	0	0	0	0	0	0	0	0

# Test material and quality control

## Test material

Each participant received three samples with freeze-dried microorganisms, designated A–C. The test material was freeze-dried in 0.5 ml portions in glass vials, as described by Peterz and Steneryd [3]. Before analysing the samples, the contents of each vial should be reconstituted in 254 ml of sterile diluent. The microorganism content of the samples and the concentrations determined at the Swedish Food Agency are listed in the table below.

**Table 12.** Microorganisms and approximate concentrations in the samples.

Sample	Microorganism	Strain			
		SLV no. <sup>1</sup>	Origin	Reference <sup>2</sup>	log <sub>10</sub> cfu ml <sup>-1</sup>
A	<i>Campylobacter coli</i>	SLV-271	Hen, faeces	CCUG 45147	1.8
	<i>Citrobacter freundii</i>	SLV-091	-	CCUG 43597	3.6
	<i>Escherichia coli</i> O157	SLV-479	-	SMI 811 86	1.4
	<i>Listeria monocytogenes</i>	SLV-513	Milk	CCUG 44510	2.2
	<i>Vibrio parahaemolyticus</i>	SLV-529	-	CCUG 38981	1.7
B	<i>Escherichia coli</i>	SLV-558	-	-	4.1
	<i>Kocuria rhizophila</i>	SLV-055	-	CCUG 35073	4.4
	<i>Salmonella</i> Stockholm	SLV-390	Chocolate powder	-	0.8
	<i>Yersinia enterocolitica</i>	SLV-408	Raw frozen dog food	CCUG 45643	1.3
C	<i>Escherichia coli</i>	SLV-558	-	-	4.2
	<i>Salmonella</i> Stockholm	SLV-390	Chocolate powder	-	2.2
	<i>Staphylococcus aureus</i>	SLV-280	Egg	-	4.5
	<i>Vibrio cholerae</i>	SLV-507	-	CCUG 34649	2.1
	<i>Yersinia enterocolitica</i>	SLV-408	Raw frozen dog food	CCUG 45643	2.6

<sup>1</sup> Internal strain identification no. at the Swedish Food Agency

<sup>2</sup> Culture collection. ATCC: American Type Culture Collection, CBS: Centraalbureau voor Schimmelcultures (Westerdijk Institute), CCUG: Culture Collection University of Gothenburg, Sweden; Fohm: Public Health Agency of Sweden.

## Quality control of the samples

In order to allow comparison of the freeze-dried samples, it is essential to have aliquots of homogeneous test material and equal volume in all vials. Quality control is performed on 10 randomly chosen vials in conjunction with manufacturing of the samples or on 5 vials if an “old” sample mixture was used and the last quality control was performed more than 6 months ago. Homogeneity of a test material is approved if, for each analysis, the values obtained for the test for “Index of dispersion” between vials ( $I_2$ ) and the test for reproducibility (T) do not simultaneously exceed 2.0 and 2.6, respectively. (For definitions of  $I_2$ , and T, see references [4] and [5] respectively.)

**Table 13.** Concentration mean (m),  $I_2$  and T values from the quality control of the samples; m is expressed in  $\log_{10}$  cfu (colony forming units) per ml of sample.

Analysis and method	A <sup>1</sup>			B <sup>2</sup>			C <sup>2</sup>		
	m	$I_2$	T	m	$I_2$	T	m	$I_2$	T
Aerobic microorganisms 30 °C NMKL method no. 86:2013	3.60	1.22	1.64	4.56	0.17	1.14	4.69	1.23	1.37
Enterobacteriaceae NMKL method no. 144:2005	3.22	1.43	1.78	4.12	1.59	1.37	4.16	<b>4.20</b>	1.64
Thermotolerant <i>Campylobacter</i> NMKL method no. 119:2007	1.63	1.30	2.59	-	-	-	-	-	-
<i>Listeria monocytogenes</i> NMKL method no. 136:2010	2.50	0.81	1.36	-	-	-	-	-	-
<i>Salmonella</i> NMKL method no. 71:1999	-	-	-	0.81	<b>3.22</b>	1.47	2.21	0.94	1.37
<i>Escherichia coli</i> O157 NMKL method no. 164:2019	1.41	1.01	1.27	-	-	-	-	-	-
Pathogenic <i>Vibrio</i> spp. NMKL method no. 156:1997	1.70	<b>5.42</b>	1.75	-	-	-	2.09	<b>7.75</b>	2.45
<i>Yersinia enterocolitica</i> NMKL method no. 117:1996	-	-	-	1.33	1.04	1.31	2.58	0.56	1.24

- No target organism or no value

<sup>1</sup> n = 10 vials analysed in duplicate

<sup>2</sup> n = 5 vials analysed in duplicate

# References

1. ISO 13528:2022 Statistical methods for use in proficiency testing by interlaboratory comparison.
2. Ilbäck J and Blom L. 2023. Protocol – Microbiological Proficiency Testing, Swedish Food Agency.
3. Peterz M and Steneryd AC. 1993. Freeze-dried mixed cultures as reference samples in quantitative and qualitative microbiological examinations of food. *Journal of Applied Bacteriology*. 74:143–148.
4. Heisterkamp SH, Hoekstra JA, van Strijp-Lockefeer NGWM, Havelaar AH, Mooijman KA, in't Veld PH, Notermans SHW, Maier EA and Griepink B. 1993. Statistical analysis of certification trials for microbiological reference materials. Luxembourg: Commission of the European Communities, Report EUR 15008 EN.
5. Mooijman KM, During M and Nagelkerke NJD 2003. MICROCRM: Preparation and control of batches of microbiological materials consisting of capsules. RIVM report 250935001/2003. RIVM, Bilthoven, Holland.



## Annex 1. Results of the participating laboratories

Lab no.	Aerobic microorganisms, 30°C			Enterobacteriaceae			Thermotolerant <i>Campylobacter</i>			<i>Listeria monocytogenes</i>			Thermotolerant <i>Campylobacter</i>			<i>Listeria monocytogenes</i>			<i>Salmonella</i>			<i>Escherichia coli</i> O157			Pathogenic <i>Vibrio</i> spp.			<i>Yersinia enterocolitica</i>		
	A	B	C	A	B	C	A	B	C	A	B	C	A	B	C	A	B	C	A	B	C	A	B	C	A	B	C	A	B	C
5553	3.66	4.72	4.78	3.56	4.28	3.82	2.52	<1	<1	-	-	-	Pos	Neg	Neg	Pos	Neg	Neg	Neg	Pos	Neg	Neg	-	-	-	-	-	-		
5612	3.59	4.6	4.61	3.46	4.4	4.18	-	-	-	3.7	0	0	-	-	-	Pos	Neg	Neg	Neg	Pos	Pos	-	-	-	-	-	-			
5615	3.88	4.11	4.72	4.54	5.04	5.08	-	-	-	-	-	-	-	-	-	Pos	Neg	Neg	Neg	Pos	Pos	-	-	-	-	-	-			
5701	3.66	4.92	4.58	-	-	-	-	-	-	-	-	-	-	-	-	-	-	-	-	-	-	-	-	-	-	-	-			
5801	4.28	4.45	4.48	3.45	4.04	3.92	-	-	-	-	-	-	-	-	-	-	-	-	-	-	-	-	-	-	-	-	-			
5808	3.74	4.73	4.55	-	-	-	-	-	-	-	-	-	-	-	-	-	-	-	Neg	Pos	Pos	-	-	-	-	-	-			
5883	3.31	4.42	4.55	2.33	4.06	4.15	-	-	-	2.43	0	0	-	-	-	Pos	Neg	Neg	Neg	Pos	Pos	-	-	-	-	-	-			
5950	-	-	-	-	-	-	-	-	-	-	-	-	-	-	-	-	-	-	-	-	-	-	-	-	-	-	-			
6109	3.81	4.85	4.7	-	-	-	-	-	-	-	-	-	-	-	-	-	-	-	Neg	Pos	Pos	Pos	Neg	Neg	-	-	-			
6175	3.07	4.86	4.28	1.84	3.83	4	-	-	-	-	-	-	-	-	-	-	-	-	Neg	Pos	Pos	-	-	-	-	-	-			
6224	4.06	4.52	4.74	3.62	4.34	4.45	-	-	-	-	-	-	-	-	-	-	-	-	-	-	-	-	-	-	-	-	-			
6253	-	-	-	-	-	-	-	-	-	-	-	-	-	-	-	Pos	Neg	Neg	Neg	Pos	Pos	-	-	-	-	-	-			
6343	3.38	4.4	4.59	3.11	4.12	4.09	-	-	-	-	-	-	-	-	-	-	-	-	-	-	-	Neg	Pos	Pos	-	-	-			
6352	3.6	4.51	4.62	3.18	3.93	3.84	-	-	-	-	-	-	-	-	-	-	-	-	Neg	Pos	Pos	-	-	-	-	-	-			
6368	3.54	4.43	4.61	3.2	4.15	4.15	-	-	-	2.56	<1	<1	-	-	-	Pos	Neg	Neg	Neg	Pos	Pos	-	-	-	Pos	Neg	Pos			
6443	3.63	4.54	4.62	3.46	4.1	3.84	-	-	-	-	-	-	-	-	-	-	-	-	-	-	-	-	-	-	-	-	-			
6456	-	-	-	-	-	-	-	-	-	-	-	-	-	-	-	Pos	Neg	Neg	Neg	Pos	Pos	-	-	-	-	-	-			
6594	-	-	-	-	-	-	-	-	-	-	-	-	-	-	-	-	-	-	-	-	-	-	-	-	-	-	-			
6686	3.66	4.57	4.79	3.36	4.3	4.26	-	-	-	2.36	<1	<1	-	-	-	Pos	Neg	Neg	Neg	Pos	Pos	-	-	-	-	-	-			
6728	4.02	4.19	4.59	3.67	4.13	4.19	-	-	-	-	-	-	-	-	-	-	-	-	-	-	-	-	-	-	-	-	-			
6870	-	-	-	-	-	-	-	-	-	-	-	-	-	-	-	Pos	Neg	Neg	Neg	-	-	-	-	-	-	-	-			
6944	3.89	4.19	4.78	-	-	-	-	-	-	-	-	-	-	-	-	Pos	Neg	Neg	Neg	-	-	-	-	-	-	-	-			
6971	3.66	4.3	4.48	3.53	4.23	4.15	-	-	-	-	-	-	-	-	-	-	-	-	-	-	-	-	-	-	-	-	-			
7182	3.89	4.28	4.66	3.73	4.1	4.23	-	-	-	-	-	-	-	-	-	-	-	-	-	-	-	-	-	-	-	-	-			
7232	3.72	4.57	4.55	-	-	-	-	-	-	-	-	-	-	-	-	-	-	-	-	-	-	-	-	-	-	-	-			
7242	-	-	-	-	-	-	-	-	-	-	-	-	-	-	-	-	-	-	-	-	-	-	-	-	-	-	-			
7248	3.48	4.62	4.61	2.73	4.04	3.97	-	-	-	2.79	<1	<1	Pos	Neg	Neg	Pos	Neg	Neg	Neg	Pos	Pos	-	-	-	-	-	-			
7330	3.536	4.481	4.562	3.519	4.362	3.989	-	-	-	2.498	<1	<1	Pos	Neg	Neg	Pos	Neg	Neg	Neg	Pos	Pos	Neg	Pos	Pos	-	-	-			
7334	3.37	4.48	4.56	-	-	-	-	-	-	-	-	-	-	-	-	-	-	-	Neg	Pos	Pos	Pos	Pos	Pos	-	-	-			
7564	3.33	4.56	4.57	3.69	4.08	4.06	1.58	<1	<1	2.36	<1	<1	Pos	Neg	Neg	Pos	Neg	Neg	Neg	Pos	Pos	-	-	-	-	-	-			
7688	3.4	4.62	4.74	3.28	4.23	3.49	-	-	-	2.48	<1	<1	Pos	Neg	Neg	Pos	Neg	Neg	Neg	Pos	Pos	-	-	-	-	-	Neg			
7728	3.67	4.6	4.46	3.28	4.18	3.96	0.48	0	0	-	-	-	Pos	Neg	Neg	Pos	Neg	Neg	Neg	Pos	Pos	-	-	-	-	-	Pos			
7750	3.84	4.32	4.68	-	-	-	-	-	-	-	-	-	-	-	-	Pos	Neg	Neg	Neg	Pos	Pos	Pos	Neg	Neg	-	-	-			
7825	3.65	4.74	4.78	3.14	4.43	4.14	-	-	-	2.41	<1	<1	-	-	-	Pos	Neg	Neg	Neg	Pos	Pos	-	-	-	-	-	-			
7876	3.48	4.57	4.68	3.33	4.12	4.18	-	-	-	2.5	<1	<1	-	-	-	Pos	Neg	Neg	Neg	Pos	Pos	-	-	-	-	-	-			
7882	4.04	4.49	4.66	3.64	4.12	4.18	-	-	-	-	-	-	Pos	Neg	Neg	Pos	Neg	Neg	Neg	Neg	Pos	-	-	-	-	-	-			
7930	3.45	4.5	4.58	3.3	4.1	3.82	-	-	-	2.53	<1	<1	-	-	-	Pos	Neg	Neg	Neg	Pos	Pos	-	-	-	-	-	-			
7940	3.66	4.33	4.68	3.48	4.2	4.48	-	-	-	-	-	-	-	-	-	-	-	-	-	-	-	-	-	-	-	-	-			
7962	3.49	4.7	4.54	3.2	4.34	4.07	-	-	-	2.53	0	0	-	-	-	Pos	Neg	Neg	Neg	Pos	Pos	-	-	-	-	-	-			
7968	-	-	-	-	-	-	-	-	-	2.45	<1	<1	Pos	Neg	Neg	Pos	Neg	Neg	Neg	Neg	Pos	-	-	-	-	-	-			
8042	-	-	-	-	-	-	-	-	-	-	-	-	-	-	-	-	-	-	Neg	Pos	Pos	-	-	-	-	-	-			
8066	-	-	-	-	-	-	-	-	-	2.55	0	0	-	-	-	Pos	Neg	Neg	Neg	-	-	-	-	-	-	-	-			
8068	3.73	5	4.48	3.23	4.85	3.39	-	-	-	-	-	-	-	-	-	Pos	Neg	Neg	Neg	Pos	Pos	-	-	-	-	-	-			
8147	3.65	4.34	4.6	3.58	3.98	3.99	-	-	-	2.46	<1	<1	-	-	-	Pos	Neg	Neg	Neg	Pos	Pos	-	-	-	-	-	-			
8165	-	-	-	3.44	4.03	4.02	1.45	<0	<0	-	-	-	Pos	Neg	Neg	Pos	Neg	Neg	Neg	Pos	Pos	Pos	Neg	Neg	-	-	Neg			
8252	3.94	4.28	4.59	-	-	-	-	-	-	2.41	<1	<1	-	-	-	Pos	Neg	Neg	Neg	Pos	Pos	-	-	-	-	-	-			
8260	3.63	4.4	4.71	3.71	4.04	4.05	-	-	-	-	-	-	-	-	-	Pos	Neg	Neg	Neg	Pos	Pos	-	-	-	-	-	-			
8313	3.98	4.51	4.72	3.48	4.14	4.08	-	-	-	-	-	-	-	-	-	Pos	Neg	Neg	Neg	Pos	Pos	-	-	-	-	-	-			
8333	3.95	5.04	4.76	2.86	4.16	3.61	-	-	-	-	-	-	-	-	-	Pos	Neg	Neg	Neg	Pos	Pos	Pos	Neg	Neg	-	-	-			
8359	3.69	4.53	4.65	3.56	4.11	3.89	-	-	-	2.49	<1	<1	Pos	Neg	Neg	Pos	Neg	Neg	Neg	Pos	Pos	-	-	-	Pos	Neg	Pos			
8397	3.9	4.22	4.74	3.22	4.15	4.2	-	-	-	2.39	0	0	-	-	-	Pos	Neg	Neg	Neg	-	-	-	-	-	-	-	-			
8435	2.78	4.75	4.41	2.48	4.36	3.95	-	-	-	2.6	<1	<1	-	-	-	Pos	Neg	Neg	Neg	Pos	Pos	-	-	-	-	-	-			
8506	3.79	4.7	4.71	-	-	-	-	-	-	-	-	-	-	-	-	Pos	Neg	Neg	Neg	Pos	Pos	Pos	Neg	Neg	-	-	-			
8528	3.79	4.17	4.72	2.95	4.2	4.2	-	-	-	-	-	-	-	-	-	-	-	-	Neg	Pos	Pos	-	-	-	-	-	-			
8568	3.94	4.78	4.66	3.56	4.17	3.27	-	-	-	-	-	-	-	-	-	Pos	Neg	Neg	Neg	Pos	Pos	Pos	Neg	Neg	-	-	-			
8626	3.48	4.23	4.14	3.3	4.23	3.85	-	-	-	2.11	0	0	-	-	-	Pos	Neg	Neg	Neg	Pos	Pos	-	-	-	-	-	-			
8628	3.93	4.26	4.76	3.6	4.22	4.14	-	-	-	2.39	0	0	-	-	-	Pos	Neg	Neg	Neg	Pos	Pos	-	-	-	Pos	Neg	Pos			

# Annex 1. Results of the participating laboratories

Lab no.	Aerobic microorganisms, 30°C			Enterobacteriaceae			Thermotolerant Campylobacter			Listeria monocytogenes			Thermotolerant Campylobacter			Listeria monocytogenes			Salmonella			Escherichia coli O157			Pathogenic Vibrio spp.			Yersinia enterocolitica		
	A	B	C	A	B	C	A	B	C	A	B	C	A	B	C	A	B	C	A	B	C	A	B	C	A	B	C	A	B	C
8734	3.93	4.32	5.02	3.59	4.38	4.49	-	-	-	2.51	0	0	-	-	-	-	-	-	-	-	-	-	-	-	-	-	-	-		
8742	3	4.43	4.45	-	-	-	-	-	-	-	-	-	-	-	Pos	Neg	Neg	Neg	Pos	Pos	-	-	-	-	-	-	-	-		
8756	4	4.7	4.84	3.18	4.45	4.32	-	-	-	-	-	-	-	-	-	-	-	-	-	Neg	Pos	Pos	-	-	-	-	-	-		
8766	3.48	4.72	4.62	3.26	4.58	4.08	-	-	-	2.41	0	0	-	-	Pos	Neg	Neg	Neg	Pos	Pos	-	-	-	-	-	-	-	-		
8862	-	-	-	-	-	-	-	-	-	-	-	-	-	-	-	-	-	-	-	-	-	-	-	-	-	-	-	-		
8955	3.62	4.46	4.63	3.48	4.2	4.08	1.36	<1	<1	2.51	<1	<1	Pos	Neg	Neg	Neg	Neg	Pos	Pos	Pos	Pos	Neg	Neg	Pos	Pos	Neg	Pos	Pos		
9002	3.62	4.34	4.7	3.23	4	4.11	1.57	0	0	2.37	0	0	-	-	Pos	Neg	Neg	Neg	Neg	Pos	Pos	-	-	-	-	-	-	-		
9034	2.57	3.49	3.73	3.38	4.21	4.29	-	-	-	-	-	-	-	-	-	-	-	-	-	-	-	-	-	-	-	-	-	-		
9078	-	-	-	-	-	-	-	-	-	-	-	-	-	-	-	-	-	-	-	-	-	-	-	-	-	-	-	-		
9086	3.81	4.92	4.65	-	-	-	-	-	-	-	-	-	-	-	-	-	-	-	Neg	Pos	Pos	-	-	-	-	-	-	-		
9217	5.48	6.35	6.76	4.75	5.9	5.65	-	-	-	-	-	-	-	-	-	-	-	-	-	Neg	Pos	Pos	-	-	-	-	-	-		
9269	-	-	-	-	-	-	-	-	-	-	-	-	-	-	-	-	-	-	Neg	Pos	Pos	-	-	-	-	-	-	-		
9429	-	-	-	-	-	-	-	-	-	-	-	-	-	-	Pos	Neg	Neg	Neg	Neg	Pos	Pos	-	-	-	-	-	-	-		
9436	3.9	4.53	4.76	3.32	4.08	3.87	1.54	<1	<1	2.52	<1	<1	-	-	Pos	Neg	Neg	Neg	Neg	Pos	Pos	Pos	Pos	Neg	Neg	-	-	-		
9441	3.45	4.38	4.59	3.3	4.08	4.26	-	-	-	2.4	0	0	-	-	Pos	Neg	Neg	Neg	Neg	Pos	Pos	-	-	-	-	-	-	-		
9453	3.43	4.51	4.68	3.71	3.96	4.22	-	-	-	-	-	-	-	-	Pos	Neg	Neg	Neg	Neg	Pos	Pos	-	-	-	-	-	-	-		
9512	3.54	4.27	4.59	3.35	4.03	4.2	-	-	-	-	-	-	-	-	Pos	Neg	Neg	Neg	Neg	Pos	Pos	-	-	-	-	-	-	-		
9558	3.34	4.54	4.43	3.08	4.04	3.79	1.43	<2	<2	2.56	<1	<1	Pos	Neg	Neg	Neg	Neg	Pos	Pos	Pos	Pos	Neg	Neg	Pos	Pos	Neg	Pos	Pos		
9662	2.36	4.79	4.71	2.8	4.41	4.08	-	-	-	2.19	0	0	-	-	Pos	Neg	Neg	Neg	Neg	Pos	Pos	-	-	-	-	-	-	-		
9716	3.63	4.74	4.75	-	-	-	-	-	-	-	-	-	-	-	Pos	Neg	Neg	Neg	Neg	Pos	Pos	-	-	-	Pos	Neg	Pos	-		
9890	3.75	4.76	4.72	3.46	4.28	4.04	-	-	-	-	-	-	-	-	Pos	Neg	Neg	Neg	-	-	-	-	-	-	-	-	-	-		
9903	3.65	4.41	4.8	3.39	4.13	4.21	-	-	-	2.12	0	0	-	-	Pos	Neg	Neg	Neg	Neg	Pos	Pos	-	-	-	-	-	-	-		
9950	-	-	-	-	-	-	-	-	-	-	-	-	-	-	Pos	Neg	Neg	Neg	-	-	-	-	-	-	-	-	-	-		
N	110	110	110	95	95	95	15	15	15	56	58	58	20	20	20	91	91	91	101	101	101	23	23	23	18	18	18	11	11	11
n	106	106	103	86	87	92	13	14	14	50	57	58	18	18	18	91	91	91	101	99	101	18	18	18	17	18	16	11	9	11
Min	2.36	3.49	3.54	0	3.54	3.27	0	0	0	2.00	0	0	-	-	-	-	-	-	-	-	-	-	-	-	-	-	-	-	-	
Max	5.48	6.35	6.76	4.75	5.90	5.65	2.52	3.30	3.51	3.70	2.53	0	-	-	-	-	-	-	-	-	-	-	-	-	-	-	-	-	-	
Med	3.65	4.48	4.63	3.41	4.15	4.07	1.43	0	0	2.43	0	0	-	-	-	-	-	-	-	-	-	-	-	-	-	-	-	-	-	
m <sub>PT</sub>	3.636	4.494	4.618	3.376	4.179	4.036	1.376	-	-	2.437	-	-	-	-	-	-	-	-	-	-	-	-	-	-	-	-	-	-	-	
s <sub>PT</sub>	0.273	0.240	0.128	0.273	0.162	0.226	0.280	-	-	0.104	-	-	-	-	-	-	-	-	-	-	-	-	-	-	-	-	-	-	-	
u <sub>PT</sub>	0.033	0.029	0.015	0.035	0.021	0.029	0.097	-	-	0.017	-	-	-	-	-	-	-	-	-	-	-	-	-	-	-	-	-	-	-	
F+	0	0	0	0	0	0	0	1	1	0	1	0	0	2	2	0	0	0	0	0	0	0	5	5	0	0	0	0	0	
F-	0	0	0	1	0	0	2	0	0	0	0	0	2	0	0	0	0	0	0	2	0	5	0	0	1	0	2	0	2	
<	3	3	5	6	1	1	0	0	0	3	0	0	-	-	-	-	-	-	-	-	-	-	-	-	-	-	-	-	-	
>	1	1	2	2	7	2	0	0	0	3	0	0	-	-	-	-	-	-	-	-	-	-	-	-	-	-	-	-	-	
Lower	2.82	3.77	4.23	2.56	3.69	3.36	0.48	0	0	2.13	0	0	-	-	-	-	-	-	-	-	-	-	-	-	-	-	-	-	-	
Upper	4.45	5.21	5.00	4.19	4.66	4.71	2.52	0	0	2.75	0	0	-	-	-	-	-	-	-	-	-	-	-	-	-	-	-	-	-	

N = number of reported results      Min = lowest reported result      Med = median value      s<sub>PT</sub> = standard deviation      F+ = false positive      < = low outlier      Lower = lowest accepted value  
n = results without annotation      Max = highest reported result      m<sub>PT</sub> = assigned value      u<sub>PT</sub> = measurement uncertainty      F- = false negative      > = high outlier      Upper = highest accepted value

- False positive or false negative
- Outside the acceptance limits
- Results "larger than" are not evaluated
- The parameter is not evaluated
- The result not evaluated
- u<sub>PT</sub> > 0,3 s<sub>PT</sub> and/or > 20 % outliers



## Annex 2. Z-scores of all participants

Lab no.	Aerobic microorganisms, 30°C			Enterobacteriaceae			Thermotolerant Campylobacter			Listeria monocytogenes			Thermotolerant Campylobacter			Listeria monocytogenes			Salmonella			Escherichia coli O157			Pathogenic Vibrio spp.			Yersinia enterocolitica		
	A	B	C	A	B	C	A	B	C	A	B	C	A	B	C	A	B	C	A	B	C	A	B	C	A	B	C	A	B	C
1237	-0.133	-1.433	-0.610	-4.000	-0.181	-0.380				4.000	0	0				0	0	0	0	0	0	0	0	0	0	0	0	0		
1254																0	0	0	0	0	0									
1545	-0.023	1.070	1.107	-0.280	1.490	-0.159				0.986	0	0				0	0	0	0	0	0									
1970	-0.573	0.528	-1.702	-0.720	0.314	-0.558	-0.202	0	0	-0.360	0	0	0	0	0	0	0	0	0	0	0	0	0	0	0	0	0	0		
2035										0.121	0	0																		
2058	-1.599	0.486	-2.405		-1.110	-2.065										0	0	0	0	0	0									
2151																0	0	0	0	0	0									
2221	-0.243	-0.182	0.717	0.234	0.066	1.127				0.313	0	0				0	0	0	0	0	0									
2317	-0.719	-0.140	-0.610	-0.500	-1.110	0.551				-0.649	0	0				0	0	0	0	0	0									
2324	-0.573	0.194	-0.766	-0.280	0.438	0.684																								
2344	-0.573	-0.307	-0.610	0.124	-1.234	-1.799	0.299	0	0	-1.322	0	0	0	0	0	0	0	0	0	0	0	0	0	0	0	0	0	0		
2386	1.187	-0.056	-0.844	1.372	0.314	0.107										0	0	0	0	0	0									
2402	0.454	1.696	-0.376	0.087	3.534	-0.602										0	0	0	0	0	0									
2637	-1.599	-0.932	0.092	0.895	-0.181	-0.513				-0.360	0	0				0	0	0	0	0	0									
2704	1.187	1.988	1.341	-0.537	4.000	-0.336				-0.168	0	0				0	0	0	0	0	0									
2745	-1.306	-0.640	-0.844	0.784	-0.553	0.329				-1.419	0	0				0	0	0	0	0	0									
2794	-1.012	-0.891	-2.170																											
2915	-0.133	1.195	-1.000	-0.537	3.162	-1.932	-1.346	0	0		0	0	0	0	0	0	0	0	0	0	0									
2944	0.344	-0.348	-0.454	0.674	-0.739	0.551				-0.938	0	0				0	0	0	0	0	0									
3031	0.417	-1.099	0.092	0.417	-0.181	0.639				-0.457	0	0				0	0	0	0	0	0									
3159	0.051	-0.390	0.248	2.142	0.314	2.900				0.602	0	0				0	0	0	0	0	0									
3305	-0.756	-0.182	1.029	1.078	0.004	0.329				-0.072	0	0	0	0	0	0	0	0	0	0	0									
3457	1.114	-1.975	-0.454	1.151	0.438	0.462				-0.553	0	0				0	0	0	0	0	0									
3515	1.040	1.654	0.873	-1.491	1.428	-0.824										0	0	0	0	0	0									
3587	-0.646	-0.515	-0.376	0.271	0.190	0.285																								
3626	-0.133	-0.390	0.639	0.087	-1.110	0.728		0	0	-1.322	0	0	0	0	0	0	0	0	0	0	0									
3825	-0.463	0.528	-0.454													0	0	0	0	0	0									
4100	0.124	-0.182	0.404	0.711	0.128	1.481	0.049	0	0	-0.168	0	0				0	0	0	0	0	0									
4171	1.114	-0.348	-0.298	-1.234	-0.862	-0.159										0	0	0	0	0	0									
4246	1.077	-1.600	0.170	0.638	-1.110	0.196										0	0	0	0	0	0									
4288	0.051	-0.891	-0.766	-1.674	-0.058	-2.287										0	0	0	0	0	0									
4339										0.505	0	0				0	0	0	0	0	0									
4358	-0.059	-0.015	0.170	-4.000	0.066	0.152										0	0	0	0	0	0									
4400	-1.232	-3.727	-4.000	-0.280	-3.958	-1.932																								
4418																														
4527																														
4560																0	0	0	0	0	0									
4635	-1.562	-0.140	-1.000	1.188	0.004	0.152										0	0	0	0	0	0									
4664	0.894	-0.682	-1.234	-0.500	-0.429	-0.469				0.890	0	0				0	0	0	0	0	0									
4683	2.067	-0.182	0.404	-1.234	0.128	-2.597				0.602	0	0				0	0	0	0	0	0									
4817	-1.489	0.236	0.170							-0.360	0	0				0	0	0	0	0	0									
4889	-0.096	0.069	0.717	1.261	-0.429	0.329				-4.000	0	0				0	0	0	0	0	0									
4944	-0.756	0.152	0.717	-0.280	0.004	0.506				0.698	0	0				0	0	0	0	0	0									
4980	0.710	-1.099	0.404	-0.353	-0.181	0.329				-0.168	0	0				0	0	0	0	0	0									
4983	1.407	-0.599	0.795	0.381	0.128	0.994																								
5028																														
5100	-1.122	-4.000	-4.000													0	0	0	0	0	0									
5182	0.234	2.780	0.951	-3.399	1.305	-1.932										0	0	0	0	0	0									
5200																0	0	0	0	0	0									
5204	0.930	1.404	-0.610	1.078	3.410	0.063	-1.203	0	0	-0.938	0	0	0	0	0	0	0	0	0	0	0									
5220	-0.683	-0.307	-2.249	0.711	-0.986	-1.267				1.083	0	0				0	0	0	0	0	0									
5261	-2.002	-2.225	-4.000	0.197	-1.358	-0.912										0	0	0	0	0	0									
5329	-0.866	-0.223	0.014	1.151	-0.243	-1.843										0	0	0	0	0	0									
5333																0	0	0	0	0	0									
5352	0.270	0.903	1.263	-0.463	-1.234	-1.755				-1.226	0	0				0	0	0	0	0	0									
5447																0	0	0	0	0	0									
5545																0	0	0	0	0	0									



## Annex 2. Z-scores of all participants

Lab no.	Aerobic microorganisms, 30°C			Enterobacteriaceae			Thermotolerant Campylobacter			Listeria monocytogenes			Thermotolerant Campylobacter			Listeria monocytogenes			Salmonella			Escherichia coli O157			Pathogenic Vibrio spp.			Yersinia enterocolitica		
	A	B	C	A	B	C	A	B	C	A	B	C	A	B	C	A	B	C	A	B	C	A	B	C	A	B	C	A	B	C
8734	1.077	-0.724	3.136	0.784	1.243	2.013				0.698	0	0																		
8742	-2.332	-0.265	-1.312																											
8756	1.333	0.861	1.731	-0.720	1.676	1.260																								
8766	-0.573	0.945	0.014	-0.426	2.481	0.196				-0.264	0	0																		
8862																														
8955	-0.059	-0.140	0.092	0.381	0.128	0.196	-0.059	0	0	0.698	0	0																		
9002	-0.059	-0.640	0.639	-0.537	-1.110	0.329	0.693	0	0	-0.649	0	0																		
9034	-3.908	-4.000	-4.000	0.014	0.190	1.127																								
9078																														
9086	0.637	1.779	0.248																											
9217	4.000	4.000	4.000	4.000	4.000	4.000																								
9269																														
9429																														
9436	0.967	0.152	1.107	-0.206	-0.615	-0.735	0.585	0	0	0.794	0	0																		
9441	-0.683	-0.474	-0.220	-0.280	-0.615	0.994				-0.360	0	0																		
9453	-0.756	0.069	0.483	1.225	-1.358	0.817																								
9512	-0.353	-0.932	-0.220	-0.096	-0.924	0.728																								
9558	-1.086	0.194	-1.468	-1.087	-0.862	-1.090	0.192	0	0	1.179	0	0																		
9662	-4.000	1.237	0.717	-2.114	1.428	0.196				-2.381	0	0																		
9716	-0.023	1.028	1.029																											
9890	0.417	1.112	0.795	0.307	0.624	0.019				0.307	0.624	0.019																		
9903	0.051	-0.348	1.419	0.051	-0.305	0.772				-3.054	0	0																		
9950																														

|z| ≥ 3,0 ("Unacceptable" or "Action")  
 2,0 < |z| < 3,0 ("Warning")  
 The parameter is not evaluated  
 The result is not evaluated

## Internal and external control for microbiological analyses of food and drinking water

All analytical activities require work of a high standard that is accurately documented. For this purpose, most participants carry out some form of internal quality assurance, but the analytical work also needs to be evaluated by an independent party. Such external quality control of laboratory competence is commonly required by accreditation bodies and can be done by taking part in proficiency testing (PT).

In a PT, identical test material is analysed by a number of participants. After reporting of results by the participants, the organiser evaluates the results and compiles them in a report.

### The Swedish Food Agency's PT program offers

- External and independent evaluation of participants analytical competence.
- Improved knowledge of analytical methods with respect to various types of organisms.
- Expert support.
- Tool for inspections regarding accreditation.
- Free samples for follow-up analyses.

For more information, visit our website: <https://www2.slv.se/absint>

### The Swedish Food Agency's reference material

As a complement to the proficiency testing, but without specific accreditation, the Swedish Food Agency also manufactures a number of reference materials (RM) for internal quality control of food and drinking water microbiological analyses, including pathogens.

For more information, visit our website: [www.livsmedelsverket.se/en/RM-micro](http://www.livsmedelsverket.se/en/RM-micro)